



Leading Conversion Technology for Power Resilience

e-one 3 - 48/230

User Manual V1.1

BEYOND THE INVERTER

THE NEW GENERATION OF POWER CONVERTERS

- EASY TO INSTALL
- COMPACT DESIGN
- HIGH EFFICIENCY
- WIDE OPERATING TEMPERATURE RANGE
- SHORT DEPTH ALLOWS 300 MM RACK INTEGRATION

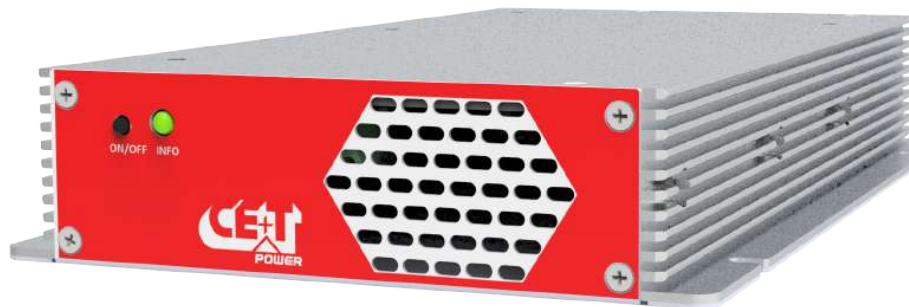

Table of content

1. CE+T at a glance	4
2. Abbreviations	5
3. Warranty and Safety Conditions	6
3.1 Handling.....	7
3.2 Surge and transients	7
3.3 Other.....	7
4. Description	8
4.1 Typical load	8
4.2 Module Specifications:	8
5. Installation	10
5.1 e-one dimensions	10
5.1.1 Mounting Kit.....	10
5.2 Wiring	11
5.2.1 REG Model - Termination Details	11
5.2.2 DC Input connection	12
5.2.3 AC Output distribution	12
5.2.4 Replacing Fuse.....	13
5.2.5 Grounding	14
5.2.6 Remote Monitoring and Control	14
6. Getting started	15
6.1 Starting procedure	15
6.2 LED indication- Alarm status	15
7. Finishing	16
8. Disassembly & Disposal	17
8.1 Disassembly.....	17
8.2 Disposal	17
9. Commissioning	18
9.1 Check list.....	18
10. Trouble shooting and Defective modules	19
10.1 Trouble shooting.....	19
10.2 Defective Modules.....	19
11. Service and Maintenance Task	20
11.1 Service.....	20
11.2 Maintenance Task	20
12. Appendix.....	21
12.1 e-one 3 - 48/230 - Wiring diagram.....	21

Release Note:

Version	Release date (DD/MM/YYYY)	Modified page number	Modifications
1.0	30/11/2018	-	First release of the Manual.
1.1	30/01/2019	8	Part number

1. CE+T at a glance

CE+T Power designs, manufactures and markets a range of products for industrial operators with mission critical applications, who are not satisfied with existing AC backup systems performances, and related maintenance costs.

Our product is an innovative AC backup solution that unlike most used UPS's

- Maximizes the operator's applications uptime;
- Operates with lowest OPEX;
- Provides best protection to disturbances;
- Optimizes footprint.

Our systems are:

- Modular
- Truly redundant
- Highly efficient
- Maintenance free
- Battery friendly

CE+T power puts 60+ years expertise in power conversion together with worldwide presence to provide customized solutions and extended service 24/7 - 365

2. Abbreviations

REG	Regular
DSP	Digital Signal Processor
AC	Alternating current
DC	Direct current
ESD	Electro Static Discharge
MET	Main Earth Terminal
USB	Universal Serial Bus
PE	Protective Earth (also called Main Protective Conductor)
N	Neutral
PCB	Printed Circuit Board

3. Warranty and Safety Conditions*

WARNING:

The electronics in the power supply system are designed for indoor, clean environment.

When installed in dusty and/or corrosive environment, outdoor or indoor, it is important to:

- Install an appropriate filter on the enclosure door, or on the room's air control system
- Keep the enclosure door closed during operation
- Replace the filters on a regular basis.

Important Safety Instructions and Save these Instructions.

- The inverter system/rack can reach hazardous leakage currents. Earthing must be carried out prior energizing the system. Earthing shall be made according to local regulations.
- Prior to any work conducted to a system/unit make sure that AC input voltage and DC input voltage is disconnected.
- **CAUTION** – Risk of electric shock. Capacitors store hazardous energy. Do not remove cover until 5 minutes after disconnecting all sources of supply.
- **CAUTION** – Disconnection of the DC source is required to de-energize this unit before servicing.
- Maximum operating ambient temperature is 40° C (104° F).
- AC and DC circuits shall be terminated with no voltage / power applied.
- Some components and terminals carry high voltage during operation. Contact may result in fatal injury.
- Warning labels must not be removed.
- Never wear metallic objects such as rings, watches, bracelets during installation, service and maintenance of the product.
- Insulated tools must be used at all times when working with live systems.
- When handling the system/units pay attention to sharp edges.
- ESD Strap must be worn when handling PCBs and open units.
- The inverter system/rack is not supplied with internal disconnect devices on input nor output.
- REG systems can be seen as independent power sources. To comply with local and international safety standards N (output) and PE shall be bonded.
- By-Pass system that have no AC input wired and connected to comply with local and international safety standards N (output) and PE shall be bonded. The bonded between N output and PE must be removed once the AC input is being connected.

* These instructions are valid for most CE+T Products/Systems. Some points might however not be valid for the product described in this manual.

- The safety standard IEC/EN62040-1 requires that, in case of output short circuit, the inverter must disconnect in maximum 5 seconds. However, if the parameter is set at a value > 5 seconds, an external protection must be provided in order that the short circuit protection operates within 5 seconds. Default setting is 60s.
- The equipment must be installed and commissioned by skilled technicians according to instructions in this manual.
- Local regulations must be adhered.
- The manufacturer declines all responsibilities if equipment is not installed, used or operated according to the instructions herein by skilled technicians according to local safety regulations.
- Warranty does not apply if the product is not installed, used and handled according to the instructions in the manuals.
- CE+T cannot be held responsible for disposal of the Inverter system and therefore the customer must segregate and dispose the materials which are potentially harmful to the environment, in accordance with the local regulations in force in the country of installation.
- If the equipment is dismantled, to dispose of the products it consists of, you must stick to the local regulations in force in the country of destination and in any case avoid causing any kind of pollution.
- System is designed for installation in an IP20 or IP21 environment. When installed in a dusty or humid environment, appropriate measures (air filtering ...) must be taken.
- All illustrations in the manual are for general reference, Refer to the technical drawing which is received along with the system for exact information.

3.1 Handling

- The cabinet shall not be lifted using lifting eyes.
- Remove weight from the cabinet by unplugging the inverters. Mark inverters clearly with shelf and position for correct. This is especially important in three phase configurations.
- Empty inverter positions must not be left open. Replace with module or cover.

3.2 Surge and transients

The mains (AC) supply of the modular inverter system shall be fitted with suitable Lightning surge suppression and Transient voltage surge suppression for the application at hand. Manufacturer's recommendations of installation shall be adhered. It is advisory to select device with alarm relay for function failure.

Indoor sites are considered to have a working lightning surge suppression device in service.

- Indoor sites: Min Class II.
- Outdoor sites: Min Class I + Class II or combined Class I+II.

3.3 Other

- Isolation test must not be performed without instructions from the manufacturer.

To download the latest documentation and software, please visit our website at www.cet-power.com or www.alpha-outback-energy.com

4. Description

e-one 3 - 48/230 is a standalone compact inverter providing a pure sine wave of 230 Vac from 48 Vdc input and deliver output power up to 350 VA. It has an IEC Socket at rear and protected with a fuse.



4.1 Typical load

- Resistive
- Inductive and resistive
- Capacitive and resistive
- Non linear load with a maximum crest factor of 2.5 : 1

4.2 Module Specifications:

General	
Part Number	T551730111
Cooling	Natural Cooling
MTBF	620 000 hours
Peak Efficiency DC/AC	> 90%
Dielectric strength DC/AC	3800 Vdc
RoHS	Compliant
Vibration	GR63 office vibration 0 to 100 hz-0.1 g / transport vibration 5-100 Hz 0.5 g 100 to 500 hz-1.5 g / Drop test
Altitude above sea without de-rating	< 1500 m / de-rating > 1500 m – 0.8 % per 100 m
Ambient / storage temperature / relative humidity	-20 to 65° C / -40 to 70° C / 95 %, non-condensing De-rating from 45° C to 65° C
Material (casing)	Aluminium & Coated steel
AC Output Power	
Nominal Output power (VA) / (W)	350 VA / 300 W
Short time overload capacity	150 % (15 seconds within T° range)
Admissible load power factor	0 lagging to 0 leading

DC Input Specifications	
Nominal voltage (DC)	48 V
Voltage range (DC)	40 - 60 V
Nominal current at 300 W / 48 VDC	7 A
Maximum input current (for 15 seconds)	11 A
Voltage ripple	2 mV psopho @ 48 V - 80% LOAD
AC Output Specifications	
Nominal voltage (AC)	230 V
Frequency / frequency accuracy	50 Hz / $\pm 0.2\%$
Total harmonic distortion (resistive load)	< 3 %
Turn on delay	20 s
Nominal current. Protected against reverse current	1.6 A at 230 VAC
Crest factor at nominal power	2.5 : 1
With short circuit management and protection	> 2.6 A (2xIn) for 15 s and then no output power from module
Signalling & Supervision	
Display	Front LED
Alarms output / supervision	Dry contact on the rear
Remote ON / OFF	On the rear
Standard Compliances	
Standards	IEC62040-1
	ETS 300 386 – 2 : 2 mV
	EN 55022 / 55032 Class A Radiated and Conducted
	ETS 300 132 – 2 : Product Standard
	EN61000-4-2 ESD criteria A - 15 kV Air and 8 kV contact
	EN61000-4-3 RF Field – Enclosure Port criteria A : 10 V/m
	EN61000-4-4 Burst - All ports criteria A : 2kV
	EN61000-4-5 Surge criteria B all ports
	EN61000-4-6 conducted RF criteria A 10V
EN61000-4-8 PFMF criteria A 30 A/m	

5. Installation

System is designed for installation in an IP20 or IP21 environment. When installed in a dusty or humid environment, appropriate measures (air filtering ...) must be taken.

The e-one is foreseen to be recessed into an electrical cabinet of 19" and 1U height standard or wall mounted. Product weight is 2 kg (4.4 lbs).

5.1 e-one dimensions

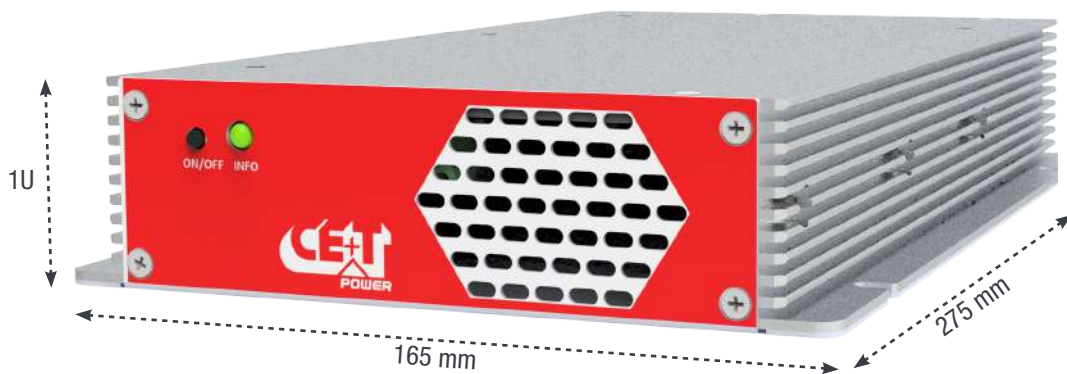

5.1.1 Mounting Kit

Make sure that you have received the right accessories for e-one.

5.1.1.1 Desk / Wall Mounting Procedure:

Step 1: Place the module on the desk or place it in the wall.

Step 2: Fix the module with M5 screws on all four sides as shown below.

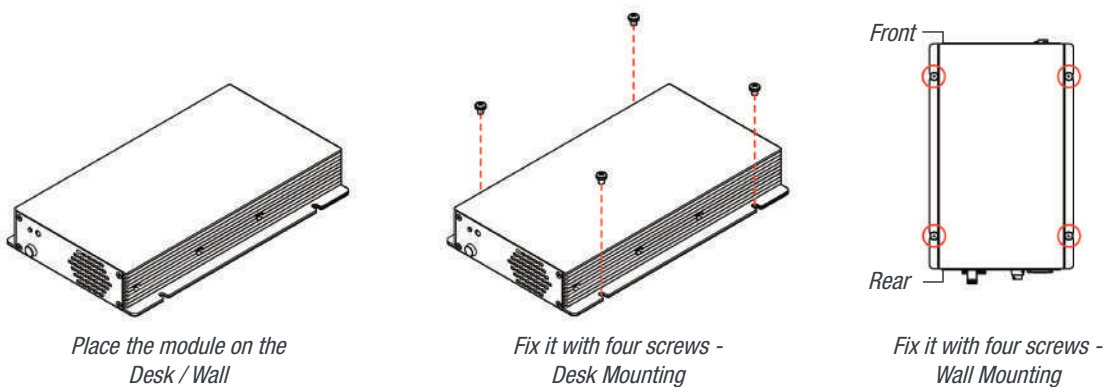

5.2 Wiring

Caution:

The e-one has internal fuses on DC inputs.

Those device do not protect the upstream cables connected to DC inputs and upstream breakers or fuses shall be set up in accordance with DC wires ratings, to meet the local national electrical code standard.

All breakers, cables and wires should be classified for min 90°C (194°F) operation. Matching respectively Line / Neutral feeder to Line / neutral input connections is required.

Before any intervention on the e-one input, operator has to make sure that power is switched off on DC leads.

Some safety labels are stuck on the e-one. They must not be removed.

The insulation cover of conductors must meet the local and international standards and the cross section must be related to the upstream protections.

5.2.1 REG Model - Termination Details

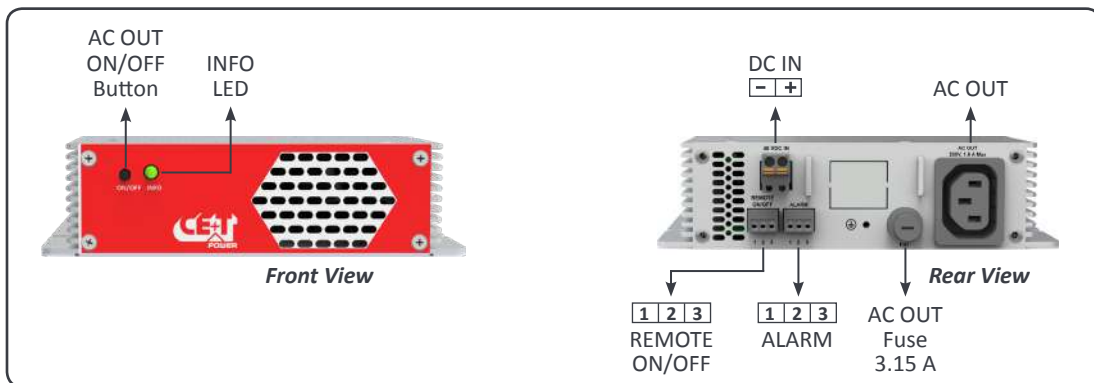

In e-one REG models:

- DC conductors connected to screw terminals must be tied with torque between 1.2 and 1.5 Nm.
- Ground conductors connected to copper plates with bolts must be tied with torque between 5 and 7 Nm.

5.2.2 DC Input connection

Integrator must provide branch circuit protection with breaking capacity related to short circuit capacity of upstream DC source.

- DC Breaker must be installed close enough to permit easy “Break Before Make”.
- Appropriate type can be chosen within the table here below.
- e-one is supplied with safety labels, which must be applied to the breaker in a visible way.

The insulation cover of connecting cables must meet the local and international standards and the cross section related to the upstream protections.

	Model	DC input current at 40 Vdc	DC breaker Recommended	Cable size	Max size
	e-one 3 - 48/230	9 A	16 A	2.5 mm ²	1 x 2.5 mm ² per pole

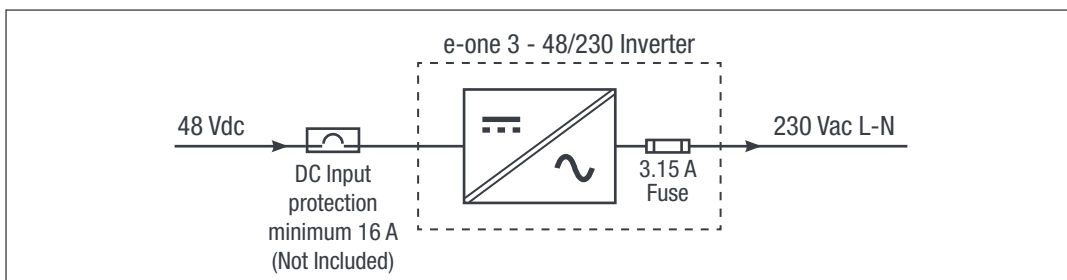

The +DC 48V supply could be earthed or work in float mode.

Adapt the breaking capacity of your breaker in relation to your installation (length cable, battery capacity).

5.2.3 AC Output distribution

The e-one unit has 1x IEC socket on output.

Caution:

The e-one should be turned OFF by remote ON/OFF action. Prior any intervention on AC output make sure DC input has been actually disconnected or, no output voltage is present.

Prior any handling of the e-one, wait a few minutes (minimum 5 minutes) for complete discharge of internal capacitors that have been energized.

Output on socket

	Model	Iout @ 230 Vac	Cable size	Max size
	e-one 3 - 48/230	1.52 A	1.5 mm ²	2.5 mm ²

Output Short-Circuit

On output short-circuit, the e-one will push > 9A (2 x In) AC current through the output terminals for 15 seconds with slow RED-Blinking indication and then stop the output permanently with a continuous RED indication. So, the module stops after 15 seconds of short-circuit.

Output on IEC socket

IEC output is protected by 3.15 amps fuse (5 x 20 mm).

Remark: e-one without static transfer switch function (REG type) can be seen as independent power sources.

5.2.4 Replacing Fuse

In-case Fuse failure, perform the following steps to replace fuse.

Fuse Details:

Manufacturer	Manufacturer Part Number	Current Rating	Voltage Rating AC	Fuse Size/Group
Schurter	0001.2509	3.15 A	250 Vac	5 mm x 20 mm

Fuse will be present at rear side of the system.

- Step 1.** By using the Flat Screw Driver gently turn the Fuse holder to 45° in anti clock wise direction. The Fuse Holder automatically ejects from the slot. (Fuse holder will not go beyond 45°).
- Step 2.** Remove the Fuse holder from the slot.
- Step 3.** Replace the appropriate new Fuse in the holder.
- Step 4.** Place the Fuse with holder in the slot.
- Step 5.** By using the Flat Screw Driver gently push and turn the Fuse holder to 45° in clock wise direction. Make sure Fuse holder is locked.

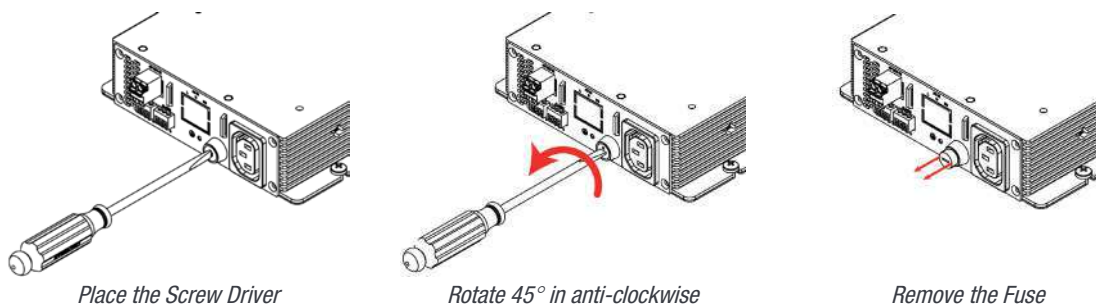

Warning: Risk of electric shock, do not replace the Fuse in system running condition.

5.2.5 Grounding

Earth connection must be done to the point referenced with symbol . Input ground must be connected to the appropriate terminal

Caution: Current leakages can reach hazardous values. For your personal, SAFETY earth connections must be done before energizing the system.



5.2.6 Remote Monitoring and Control

5.2.6.1 Alarm Connector

There is one free potential changeover contact provided. Maximum wire size is 0.5 mm². It can be used for Alarm indication purposes. It has one Major Alarm relay.

N.B. : Relays are energized while idle (i.e. relays de-energized when event occur).

MAJOR relay provide an open or close free potential contact



Relay characteristics:

- Maximum switching capacity: 1 A @ 60 VDC
- Maximum switching power: 30 W

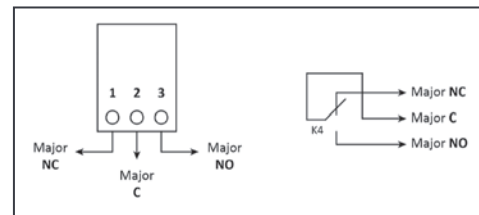

5.2.6.2 Remote ON/OFF

e-one system can be remotely activated or stopped (stand-by mode).



Changeover contacts must be used.

The voltage present on terminal 1 and 3 is +12 V (galvanically insulated). Care should be taken to avoid connecting any external voltage on terminal 1 to 3. Maximum wire size is 1 mm²

Functional table for remote ON/OFF function

States	Pin 1-3	Pin 2-3	System status
1	Open	Open	System working normally
2	Closed	Open	Output switched OFF LED OFF
3	Open	Closed	System working normally
4	Closed	Closed	Output switched OFF LED OFF

The 3 wires must be used for the redundancy on the remote ON/OFF. Use NO/NC relay contact.

6. Getting started

6.1 Starting procedure

1. Check the DC power supply (within range).
2. Turn on the DC breaker to the module. (Wait at least 30 seconds until INFO LED turns solid green).
3. Check AC output voltage at IEC socket.
4. Check that system is operating under normal conditions.

6.2 LED indication- Alarm status

e-one module indicate its functional status through module front **INFO LED**.



S. NO	INFO LED	Description	Alarm
1	OFF	No Output	✓
2	Permanent GREEN	Working Fine	-
3	Blinking GREEN	DC Source Out-of-range	✓
4	Blinking ORANGE	Output Power / VA De-rating	-
5	Slow - Blinking RED	Short-circuit Sequence	-
6	Fast - Blinking RED	Module Over-Temperature and Output OFF	✓
7	Permanent RED	Output OFF due to Permanent Short-Circuit	✓
8	Blinking RED- GREEN	Load Power too High and Output OFF	✓

7. Finishing

1. Make sure that the inverter is properly fixed.
2. Make sure that the inverter is connected to Ground.
3. Make sure that DC upstream breaker is switched OFF.
4. Make sure that all cables are according to recommendations and local regulations.
5. Make sure that all cables are strained relieved.
6. Make sure that the Remote ON/OFF is appropriately wired.
7. Re tighten all electrical terminations.
8. Make sure that DC polarity is according to marking.
9. Switch ON DC breaker.

Inverter starts and delivers AC output voltage.

8. Disassembly & Disposal

8.1 Disassembly

Switch off the upstream and downstream protective elements to stop the function of Inverter system.

- Disconnect the wires from the terminals.
- Ensure that all the cables (including PE, communication etc) are removed.
- Check that all the cables are moved away from the system.
- Unscrew the system from the mounting position.
- Dismantle the system completely and segregate the materials.
 - Enclosure & accessories.
 - Cables.
 - Wound components.
 - PCBA etc.

8.2 Disposal

CE+T cannot be held responsible for disposal of the Inverter system and therefore the customer must segregate and dispose the materials which are potentially harmful to the environment, in accordance with the local regulations in force in the country of installation.

If the equipment is dismantled, to dispose of the products it consists of, you must stick to the local regulations in force in the country of destination and in any case avoid causing any kind of pollution.

9. Commissioning

The DC breaker is a protection device. When modules are plugged in a system please make sure the corresponding DC breaker is engaged in the ON position. Failure to observe this rules will result not to have all module operating when running on DC.

Installation and commissioning must be done and conducted by trained people fully authorized to act on installation.

It is prohibited to perform any isolation test without instruction from manufacturer.

Equipments are not cover by warranty if procedures are not respected.

9.1 Check list

DATA	
Date	
Performed by	
Site	
Inverter serial number	
ACTION	OK/ N.OK
Check the DC power supply and switch ON the DC breakers	
Check if inverters are working properly (INFO LED Green)	
Check output voltage	
Check if system has no alarm	
Switch OFF the system	
Test on load (if available)	

10. Trouble shooting and Defective modules

10.1 Trouble shooting

Inverter does not power up:	<p>Check the DC terminals are properly connected and also ensure the polarity.</p> <p>Check DC input is in range and DC breaker is switched ON (DC breakers)</p> <p>Check for loose terminations</p>
Inverter does not start:	<p>Check front ON/OFF button and Remote ON/OFF terminal</p>
Inverter only run on AC or DC:	<p>Check the Voltage range for DC.</p>
No output power:	<p>Check output breaker</p>

10.2 Defective Modules

- A repair request should follow the regular logistics chain:
End-user => Distributor => CE+T Power.
- Before returning a defective product, a RMA number must be requested through the www.alpha-outback-energy.com extranet. Repair registering guidelines may be requested by email at info@alpha-outback-energy.com.
- The RMA number should be mentioned on all shipping documents related to the repair.
- Be aware that products shipped back to CE+T Power without being registered first will not be treated with high priority! (Label shown here is only for representation)

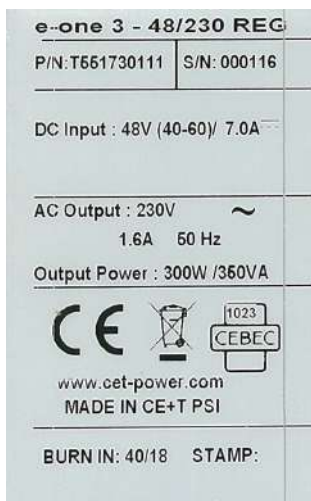

11. Service and Maintenance Task

11.1 Service

For Service

- Check Service Level Agreement (SLA) of your vendor. Most of the time they provide assistance on call with integrated service. If such SLA is in place, you must call their assistance first.
- If your vendor doesn't provide such assistance (*) you may contact Alpha and Outback Energy through email: info@alpha-outback-energy.com

(*) CE+T will redirect your call to your vendor if he has such SLA in place.

11.2 Maintenance Task

Maintenance task should be performed only by trained personnel with sufficient acknowledge on the product.

Manual check

- Validate DC input and AC output voltage with multi-meter
- Replace dust filter (if present)
- Take a snap shot of the inverter

Optional

- With an infrared camera check termination hot spots
 - Tighten terminations

12. Appendix

12.1 e-one 3 - 48/230 - Wiring diagram

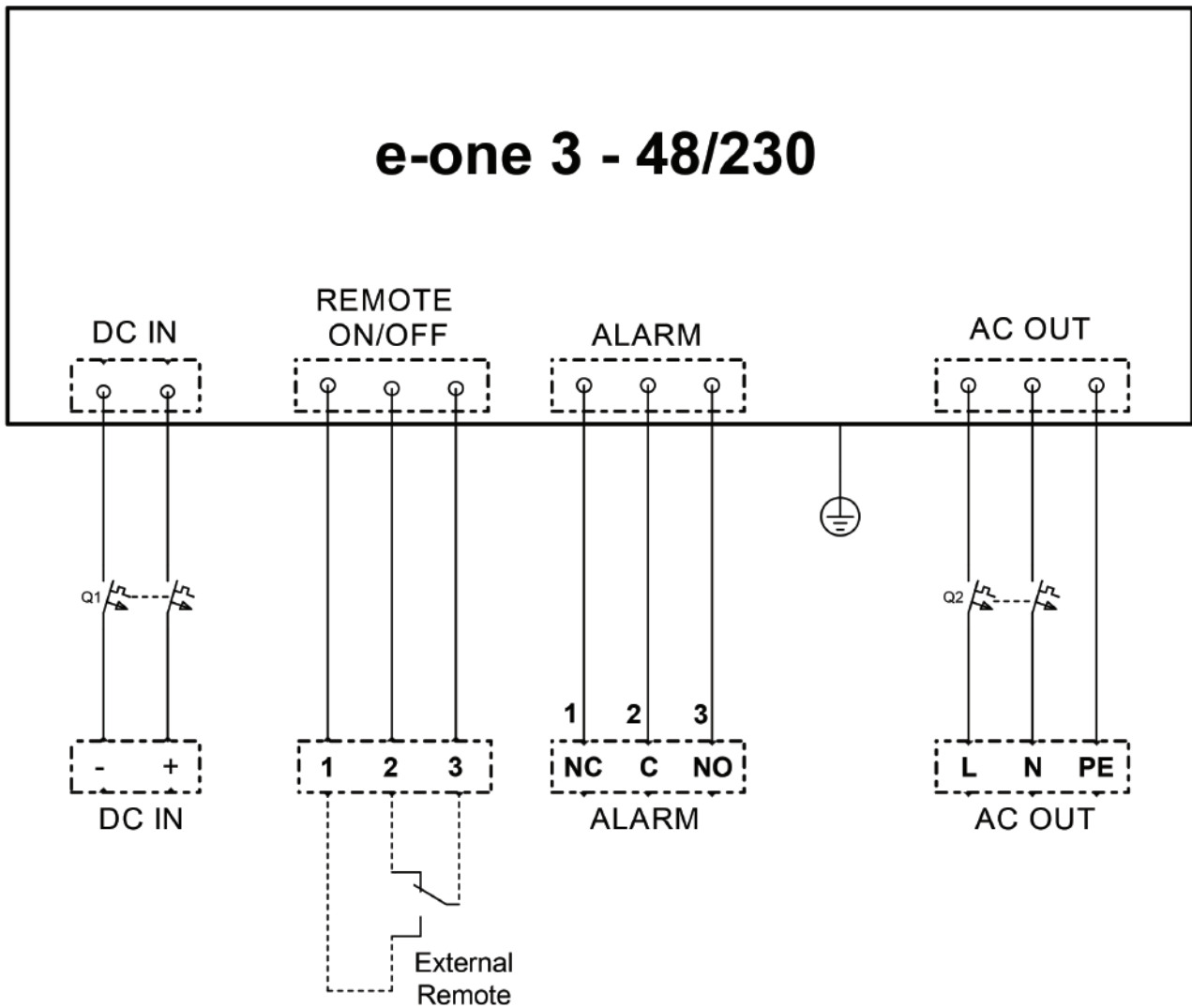



Worldwide Corporate Offices

Headquarter Germany

Hansastrasse 8
D-91126 Schwabach
Tel: +49 9122 79889 0
Fax: +49 9122 79889 21
Mail: info@alpha-outback-energy.com

Eastern Europe

ee@alpha-outback-energy.com

France and Benelux

fbnl@alpha-outback-energy.com

Russia

russia@alpha-outback-energy.com

Middle East

me@alpha-outback-energy.com

Spain

spain@alpha-outback-energy.com

Africa

africa@alpha-outback-energy.com

Alpha and Outback Energy GmbH reserves the right to make changes to the products and information contained in this document without notice. Copyright © 2020 Alpha and Outback Energy GmbH. All Rights reserved.

For more information please visit www.alpha-outback-energy.com