

NOTE: These instructions require knowledge of menu navigation in password-secured MATE3s menus. For information on advanced navigation and locating the required menus, see the *MATE3s Programming Guide*.

To upload firmware to the MATE3s:

1. Insert the SD card into the MATE3s (A).
2. In **Main Menu** under **Firmware Update** (B), select the appropriate device as shown in C. This may be **MATE3s**, **FXR inverter** (shown here), or another device). Press **<Update>** (D).

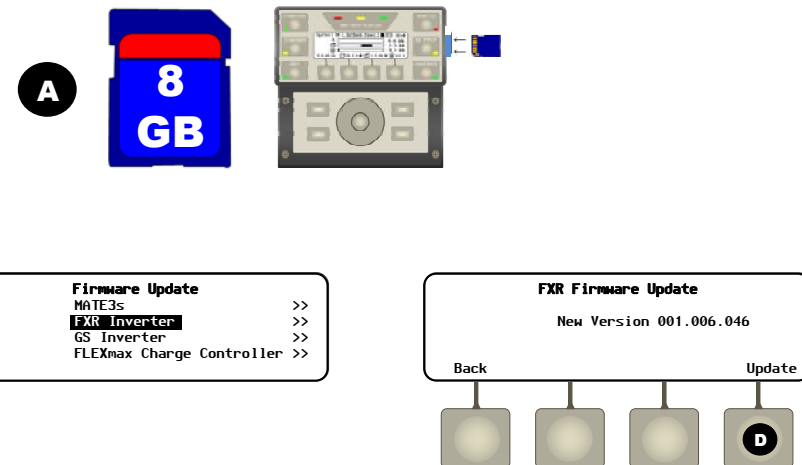

3. The screen will show updates for several minutes with the **BATTERY STATUS** yellow LED indicator flashing rapidly (E). A status bar will appear showing the percentage completed. Revision is complete when the home screen reappears.

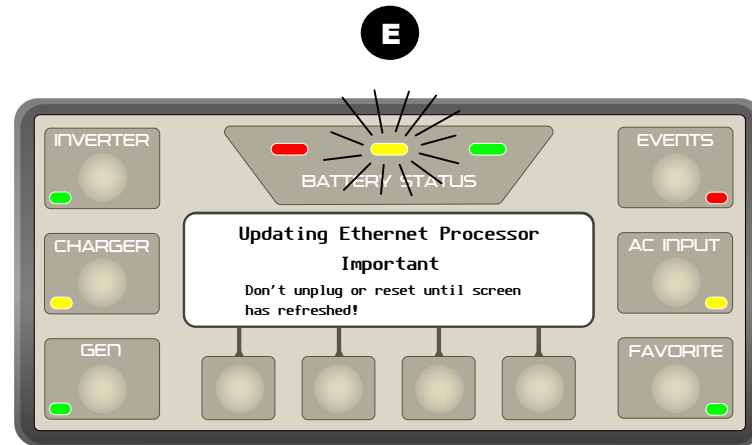

CAUTION: EQUIPMENT DAMAGE
Do not disconnect the MATE3s or otherwise stop the upload before completion. Any interruption could permanently corrupt the MATE3s.

NOTE
For instructions on installing .GIP files for Grid Support functionality, see the inverter *Installation Manual*.

MATE3s System Display and Controller

Contents:

Installation.....	1-2
LED Indicators.....	3-5
Home Screens.....	5-7
Soft Keys.....	7-14
Hot Keys.....	15-18
Firmware Updates.....	19-20

Features

- | | |
|------------------------------|---|
| A: LCD display screen | E: Navigation keys |
| B: Soft keys | F: Mounting Holes |
| C: Hot keys | G: Ethernet port |
| D: SD card slot | H: HUB Communications Manager port |

NOTE: This document assumes knowledge of features, functions, and operation of other OutBack products. Consult appropriate literature as necessary.

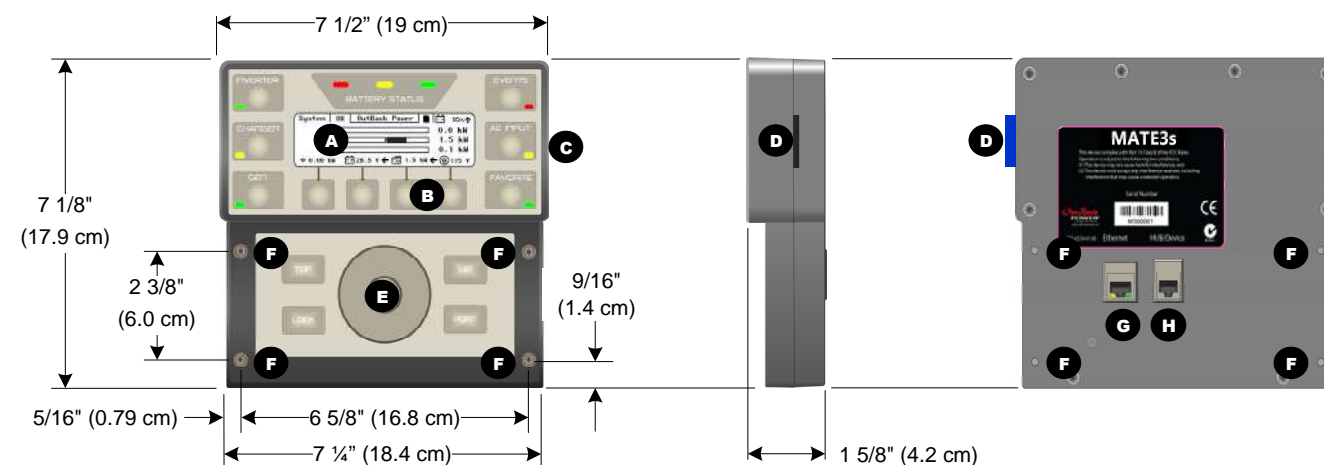

IMPORTANT
Signal degradation can result if cable is run in conduit with AC wiring or in other electrically "noisy" environments; these can affect the maximum length the cable can run without incurring transmission errors.

CAUTION: EQUIPMENT DAMAGE
The MATE3s is intended for indoor installations only.

IMPORTANT:
Not intended for use with life support equipment.

NOTES

- ❖ The MATE3s voltage is less than 30 Vdc and is thus considered a "limited energy" circuit normally requiring no conduit.
- ❖ CAT5 cable is not as strong as house wiring and must be handled carefully. Avoid kinking the cable or tearing its outer sheathing.
- ❖ Use plastic standoff cable staples, J-hooks, or cable trays to support long runs of CAT5 cable. *Do not splice cables.*

Warranty Summary

OutBack Power Technologies warrants that the products it manufactures will be free from defects in materials and workmanship for a period of five (5) years subject to the conditions set forth in the warranty detail, found in the product manual.

OutBack Power Technologies cannot be responsible for system failure, damages, or injury resulting from improper installation of their products.

Notice of Copyright

MATE3s System Display and Controller Overview Guide © 2017 by OutBack Power Technologies. All Rights Reserved.

Date and Revision

August 2017, Revision B

Mounting Brackets

Items 1, 2, and 3 are the MATE3s mounting options from OutBack.

1. FW-MB3 (FLEXware Mounting Bracket) mounts on an OutBack FLEXware assembly or on a Radian-class inverter.
2. FW-MB-F (Flat Mount Kit) mounts against a wall surface and an outlet box. The cables are recessed into the wall.
3. FW-MB3-S (Surface Mount Kit) mounts against a flat surface but does not require an opening in the wall.



Mounting Without Brackets

Item 4 is a semi-transparent front view which also shows the ports and other back features.

To mount the MATE3s on the wall without the accessory brackets:

1. Cut a hole in the surface at the location and size shown in 4. This allows room for the CAT5 cables to protrude through the wall.
2. Place the MATE3s on the wall with the cables inside the hole. Mark the mounting holes (F) by pushing a long nail into the mounting holes and putting a leader hole in the wall surface.
NOTE: Do not use a nail that is larger than the mounting screws.

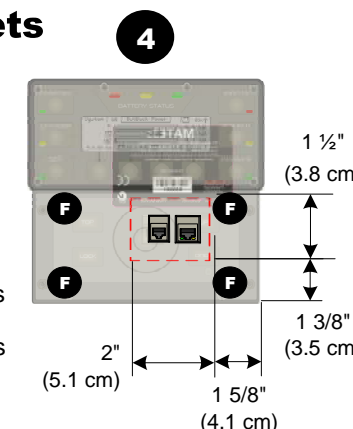

Product Configurations (examples)

The MATE3s connects to other OutBack products using the HUB port. To learn what configurations are available, see the appropriate manual. To make MATE3s settings for a configuration, see the *MATE3s Programming Guide*.

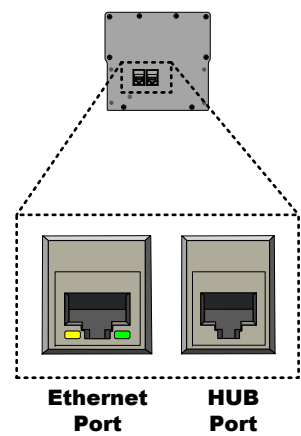
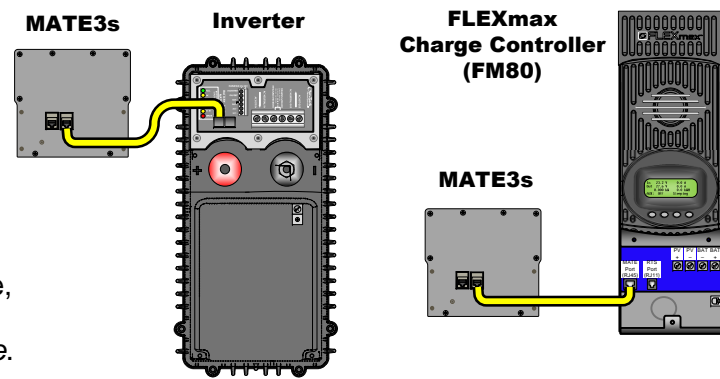

NOTE:
All communications use CAT5 (non-crossover) cable.

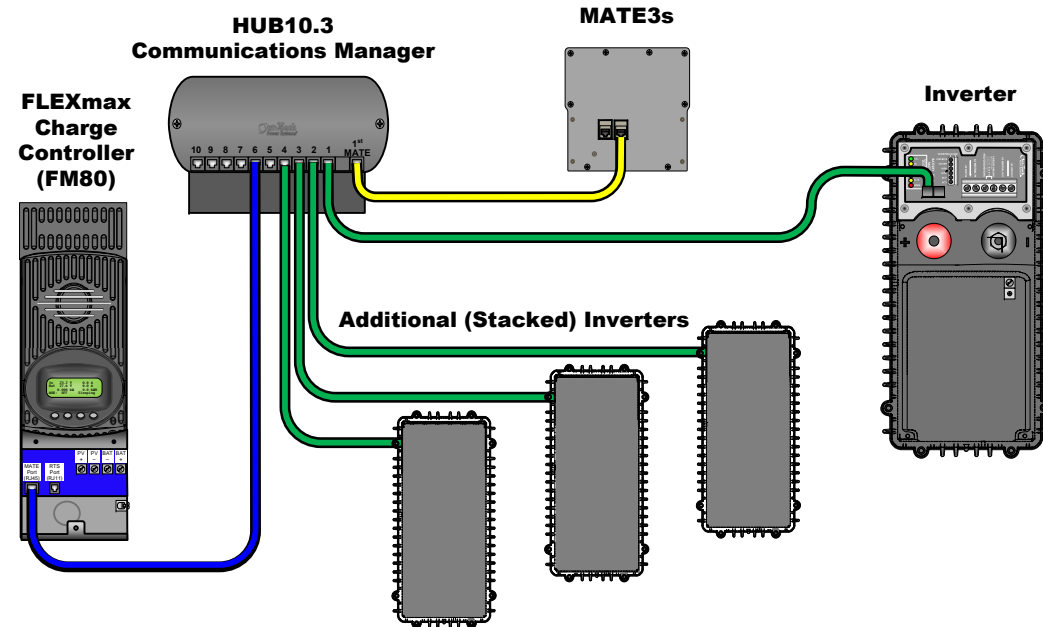

Communications Interfacing (examples)

The MATE3s interfaces with other devices using the Ethernet port. The connections here are used for Internet access with the OPTICS RE interface. Other connections are possible. The MATE3s can connect using a network switch or a wireless network router.

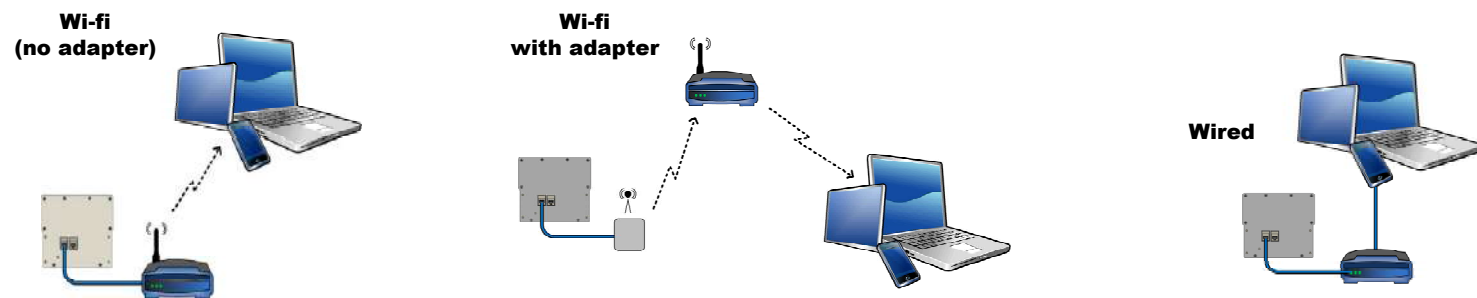

Battery LED Indicators

Three LED indicators indicate the condition of the battery bank.

- GREEN means the batteries have an adequate charge at that time. It does not always mean they are full. If the FLEXnet DC battery monitor (FN-DC) is installed, this means the batteries are 80% State of Charge (SOC).
- YELLOW means the batteries are somewhat discharged. If the FN-DC is installed, this means the battery SOC is between 60% and 70%.
- RED means the batteries are greatly discharged and may require attention. If the FN-DC is installed, this means the battery SOC is less than 60%. This indicator may be accompanied by a **Low Battery V** error and the **EVENTS** indicator. (See page 5.)

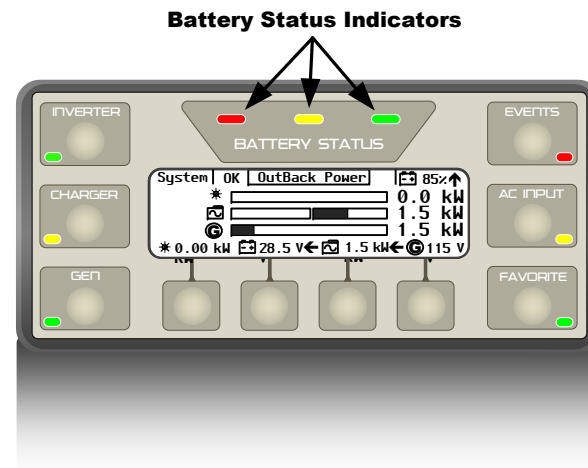

Color	12 Vdc Unit	24 Vdc Unit ± 0.2 Vdc	36 Vdc Unit ± 0.3 Vdc	48 Vdc Unit ± 0.4 Vdc	Battery Status
GREEN	12.5 Vdc or higher	25.0 Vdc or higher	37.5 Vdc or higher	50.0 Vdc or higher	Acceptable
YELLOW	11.5 to 12.4 Vdc	23.0 to 24.8 Vdc	34.5 to 37.2 Vdc	46.0 to 49.6 Vdc	Usable
RED	11.4 Vdc or lower	22.8 Vdc or lower	34.2 Vdc or lower	45.6 Vdc or higher	Low

NOTES:

- ❖ Gaps in the table (higher-voltage units) are due to the resolution of the inverter's DC meter.
- ❖ These voltage settings are not the same as the inverter's **Low Battery Cut-Off** voltage. The Battery LED settings cannot be changed.
- ❖ Voltages higher than shown in the GREEN row usually means that the batteries are charging.

Displays

When the MATE3s is plugged into a powered OutBack product, it immediately powers up and cycles through the startup screens. It will proceed to locate and identify the attached components and the ports they occupy on the HUB. It will then stop on the "Home" screen.

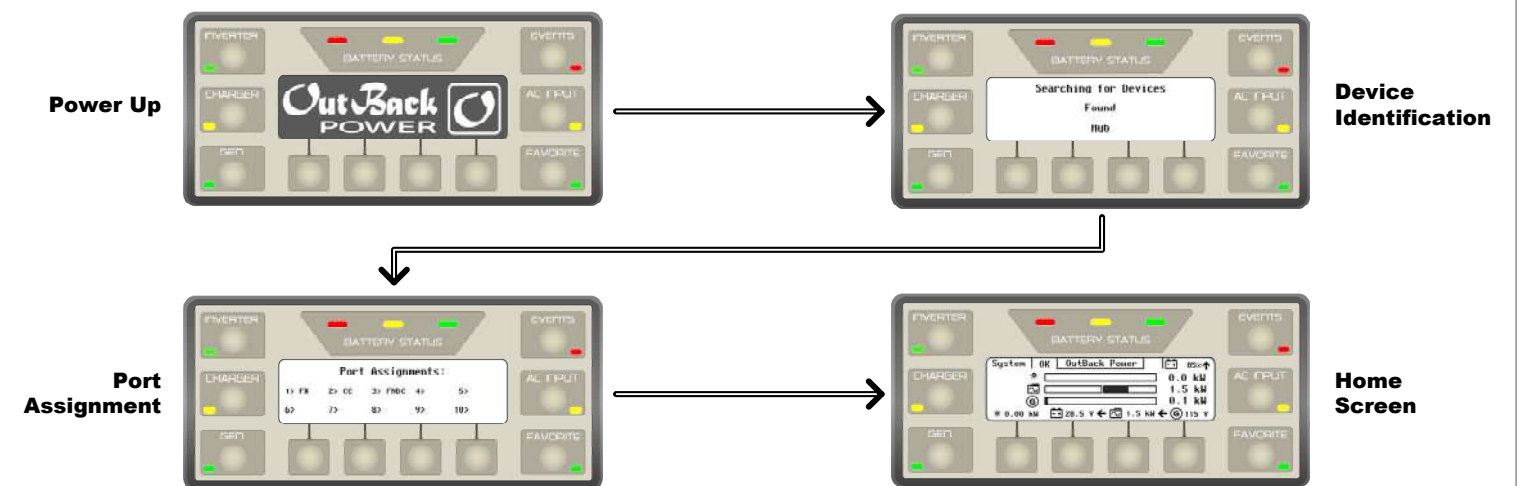

System LED Indicators

The six System indicators show the status of different aspects of the system. In most cases, more information is available by pressing the “hot” key where the indicator is located. Pages 14 through 18 have more information on these hot keys.

INVERTER indicator (green): This shows the status of the inverter (or the master inverter in a stacked system).

- ON (solid): inverter is converting DC power to AC in order to power loads.
- ON (flash): inverter is in Search mode.
- OFF: the inverter is not converting DC to AC. The AC source may be powering the loads.

CHARGER indicator (yellow): This shows the status of any charger active in an OutBack system.

- ON (solid): a device on the HUB is delivering more than a minimal amount of charging power. The device may be an inverter or a charge controller.
- ON (flash): the batteries are being equalized.
- OFF: no device is actively charging the batteries. The charger may be off. It may be on but in a resting state. Alternately, it may be on with the charging source disconnected or unavailable.

GEN indicator (green): This shows the status of a generator that is controlled by the Advanced Generator Start (AGS) function.

- ON (solid): The generator is running after an **ON** command in the **Generator Status** menu. The generator is determined to be running based on input AC voltage (if the generator type is AC). This LED will usually illuminate in conjunction with the **AC INPUT** LED indicator. It only illuminates when an AC generator is used.
- OFF: The **Generator Status** menu has been set to **OFF**, or the AGS function has not been enabled. If the generator shuts down or stops delivering power, this indicator will remain on until a generator fault is declared.

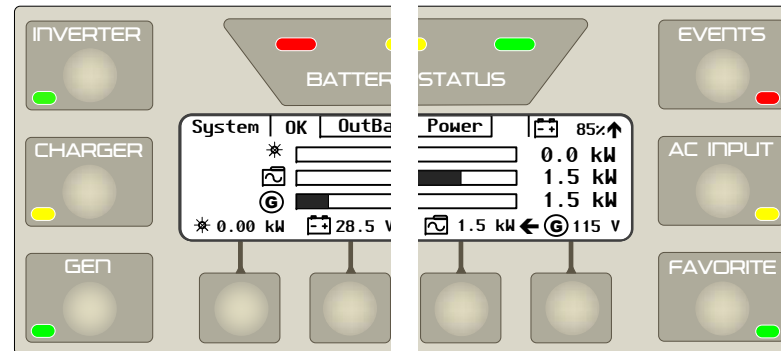

EVENTS indicator (red): An “event” is a change in status, externally imposed on a device on the HUB (an on/off command, an automatic generator start, loss of grid power, etc.). The **Event History** screen logs all events for potential troubleshooting (see page 17). The LED indicator means that an event requires acknowledgement. Usually it only illuminates when a fault occurs.

- ON (solid): An error has occurred. This is usually accompanied by inverter shutdown. This can also show a generator fault if the voltage is lost from an automatic generator.
- ON (flash): A warning has occurred. It stops flashing if conditions return to normal.
- OFF: No particular status. Events may be logged in **Event History**, but they do not require attention.

AC INPUT indicator (yellow): This shows the status of the inverter's AC input (the master inverter in a stacked system).

- ON (solid): The AC source is connected and providing power. Unit may or may not be charging the batteries, depending on settings.
- ON (flash): The source has not been accepted. If this continues, the source may have quality issues. (See page 10.) The **AC Input Status** may be set to **Drop**. (See page 18.) Also, HBX or a similar function may have disconnected the source. (See the *MATE3s Programming Guide*.)
- OFF: no AC source is detected.

FAVORITE indicator (green): This indicates the use of this hot key to select often-used menus for rapid access.

- ON (solid): The hot key has been pressed and a Favorite can be selected.
- ON (flash): The hot key has been held down to program a Favorite.
- OFF: No particular status. The indicator only illuminates upon pressing the hot key.

Home Screen

The Home screen appears after the MATE3s detects the devices connected to it. Home screens display different types of information depending on the system type selected. This is set in the **System Information** screen. (See the *MATE3s Programming Guide*). Three **System Types** (and Home screens) are available:

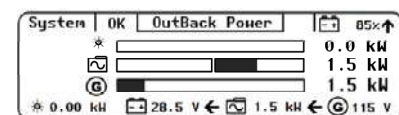

- **Off Grid** is for when no utility grid is available. Often used with a generator. This is the default screen.

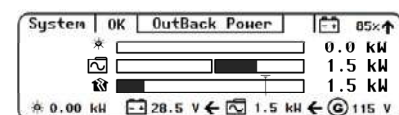

- **Backup** is for using the inverter system to back up the utility grid.

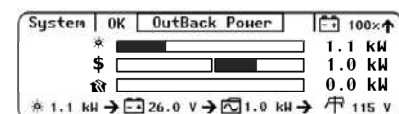

- **Grid Tied** is for grid-interactive inverters capable of returning power to the utility grid. Most commonly used with renewable energy systems.

NOTE: Selecting **Grid Tied** does not activate the grid-interactive function. It simply arranges the screen to display grid-interactive data most effectively. The function must be set in the inverter itself. FXR- and Radian-class inverters need to be placed in the AC input mode which is also called **Grid Tied**. GTFX and GVFX inverters have this function enabled by default.) See the applicable inverter literature.

For a legend of the screen symbols, see page 6.

Meter Bars

Much of the Home screen data is shown by kilowatt meters in the form of black bars next to the various icons. These meter bars expand to the right or to the left. Not all data is present in all cases. Each home screen uses a different combination of meter bars. The scale of each bar is described on page 7. The parameters for the bars are based on the data in **System Information**.

- The ⚡ meter bar represents the charge controller output. If no charge controller is detected, this bar is not present.
- The left ⏏ meter bar represents inverter output when **System Type** is set to **Off Grid** or **Backup**.
- The right ⏏ meter bar represents the inverter's charger output when **System Type** is set to **Off Grid** or **Backup**.
- The Ⓞ meter bar represents the generator output when **System Type** is set to **Off Grid**.
- The left \$ meter bar represents the power bought from the grid when **System Type** is set to **Grid Tied**.
- The right \$ meter bar represents the amount of power sold by the inverter when **System Type** is set to **Grid Tied**.
- The ⏏ meter bar represents the amount of power used by the output loads when **System Type** is set to **Grid Tied** or **Backup**.

LEGEND	
Icon(s)	Description
A OK	System status
B █	An SD card has been inserted
C [Battery] ↓ or ↑	Net current flowing out of (↓) or into (↑) batteries; also shows % SOC (State Of Charge, as measured by FN-DC)
D [Sun] → [Battery]	PV current charging batteries; meter bar expands left to right
E [Battery] ___ V	Battery voltage
F [Battery] → [Inverter] or ←	Battery current used by inverter (→) or charged by inverter (←)
G [Inverter] ___ kW	Kilowatts used by inverter or charger
H [Inverter] ← [Generator]	Generator current used by inverter and loads
I [Inverter] → [Grid] or ←	Grid current used by inverter and loads (←), or inverter current sold to grid (→)
J [Generator] ___ V	Generator (or AC source) voltage (and power); meter bar expands left to right
K [Grid] ___ V	Utility Grid (or AC source) voltage
L [meter bars]	Left bar = inverter output, expands right to left Right bar = charger output; expands left to right
M \$ meter bars	Left bar = power bought, expands right to left Right bar = power sold; expands left to right
N [meter bar]	Power delivered to inverter output (loads)

Meter Bar or Metering Notes
If no FLEXnet DC is present, this is replaced by another display of E .
Meter bar scaled by Array Wattage setting; not present if no controller
Not compensated for temperature
In Grid Tied mode, current used (→) can also mean current sold; see I
Measured by L and M
Meter bar scaled by Gen kW Rating setting; does not operate in PassThru
Meter bar scaled by Gen kW Rating setting
Left bar scaled by Gen kW Rating setting Right bar scaled to total of Max Inverter kW and Charger kW settings
Left bar scaled by Gen kW Rating setting Right bar scaled by Max Charger kW setting
Grid Tied system type: meter bar scaled to Max Inverter kW setting Exception: in PassThru, it is scaled to 7.2 kW x total number of inverters
Backup : meter bar scaled to 125% of Max Inverter kW setting; 100% is marked with ▮

- A** In the **Off Grid** or **Backup** system types: "OK" is replaced with !Ⓞ (with an event message) during a generator fault.
- In the **Grid Tied** system type: "OK" is replaced with !Ⓜ (with an event message) during a grid fault.
- In any system type:
 - "OK" is replaced with ![Battery] or X[Battery] (with an event message) if the FN-DC is present and registers a battery problem.
 - "OK" is replaced with ![Inverter] (with an event message) during an inverter fault.
- J** In the **Backup** system type, the **System Information** menu must have an AC generator selected. Otherwise this field is blank. (See the *MATE3s Programming Guide*.)
- L** If **Gen Type** is set to DC, then the left meter bar is scaled according to the **Max Inverter kW** setting.

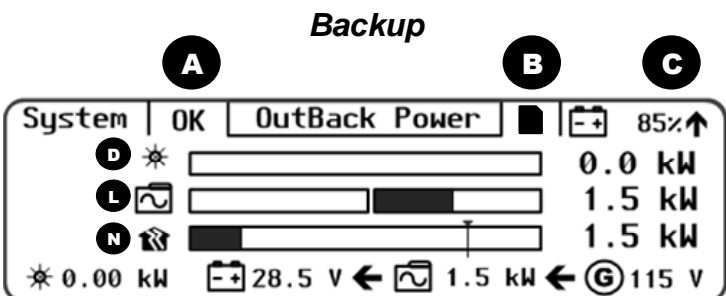
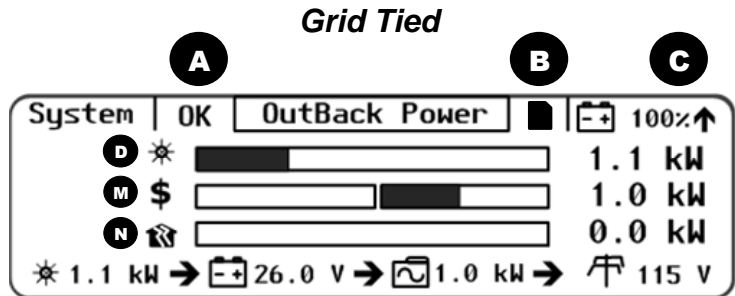
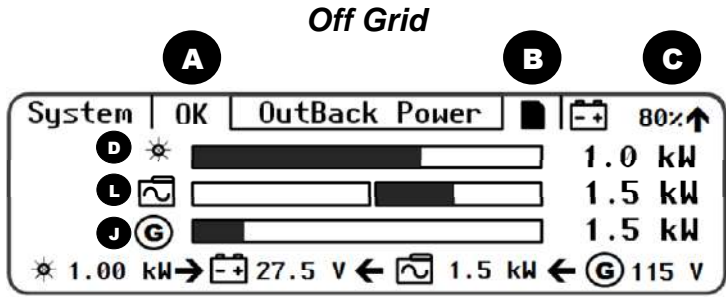

Basic Navigation

Soft Keys

Four "soft" keys are located directly below the display. Soft key functions will vary depending on the location. These functions are identified by icons or text directly above the key. Occasionally not all four soft keys are used.

In all cases where displayed, the **<Back>** soft key returns to the previous screen. The **<Port>** soft key cycles through each device connected to the network. When a specific port is selected, the device on that port can be individually programmed with whatever options are available. (Programming is often global unless assigned to a particular port.) Other soft keys are described as appropriate.

Home Screen Soft Keys

- See the following pages for displays and descriptions.
- The **<Charge Controller>** soft key (**O**) displays information on all FLEXmax charge controllers. If no controllers are detected by the HUB Communications Manager, **Q** is inoperative. (The [Sun] symbol and meter bar are not present.) See page 14.
 - The **<Battery>** soft key (**P**) displays information on the battery bank. The information available depends on whether the FLEXnet DC battery monitor is installed. See page 12.
 - The **<Inverter>** soft key (**Q**) displays information on any inverters present on the HUB. If no inverters are present, **Q** is inoperative. (The [Battery] symbol is not present.) See page 8.
 - For FX-class inverters: In the **Off Grid** system type, **R** is **<Input Select>**. It may not have a symbol. The [Generator] symbol only appears if a generator is running. (See **J**.) In **Grid Tied**, **R** is **<Grid Status>**. [Grid] will appear. In **Backup**, **R** is inoperative. See page 8.
 - In the **Off Grid** system type: For FXR-class inverters, **S** is the **<Input Select>** soft key. For Radian-class inverters, **S** is the **<Input Priority>** soft key. It may not have a symbol. The [Generator] symbol only appears if a generator is running. (See **J**.) For both FXR- and Radian-class: In **Grid Tied** or **Off Grid**, **S** is the **<Grid Status>** soft key. [Grid] will appear. See page 8.

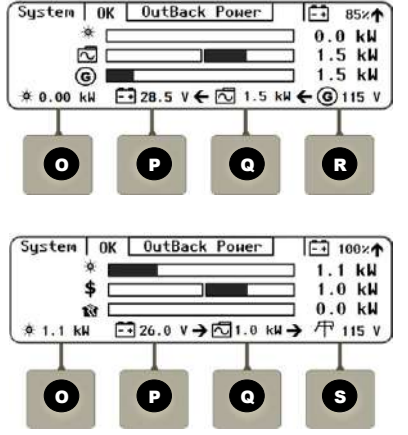

Input Select, Input Priority, and Grid Status Soft Keys

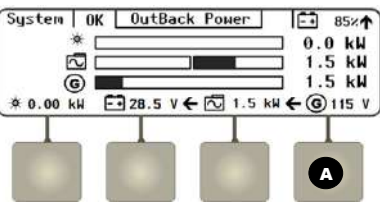

A	System Type:	Off Grid	Grid Tied	Backup
	FX-class	A1	A3	—
	FXR-class	A1	A3	A3
	Radian-class	A2	A3	A3

- The **Input Select** screen (**A1**) allows two AC sources of different sizes when switched externally to a single input. (FX-class and FXR-class)
- The **Input Priority** screen (**A2**) selects which of two AC sources is accepted if both are active at the same time. It also shows the present source. (Radian-class)

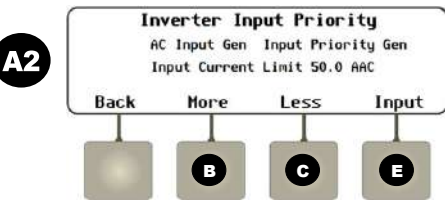
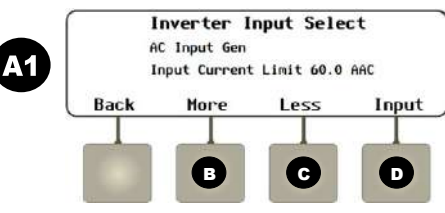

- Screen Items (A1 and A2):**
- AC Input** – Gen or Grid
 - Input Current Limit** – xx.x to xx.x Aac (varies with inverter model)
 - In screen **A1**, the **<Input>** soft key (**D**) selects between the utility grid or a generator. Each selection has a pre-set value for the **Input Current Limit**.
 - In screen **A2**, the **<Input>** soft key (**E**) chooses either the utility grid or the generator to take priority. Each selection has a pre-set value for the **Input Current Limit**.
 - The **<Less>** or **<More>** soft keys (**B** and **C**) can adjust these values in either screen.

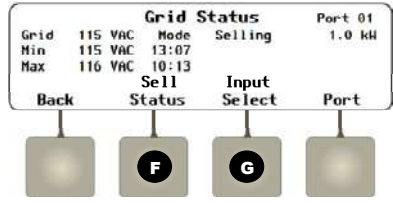

- The **<Grid Status>** soft key (**A3**) brings up AC input data. If the inverter is not in the **Grid Tied** input mode or connected to the utility grid, not all items will function.
- Screen Items (A3):**
- Grid:** the present AC voltage from the source (the utility grid).
 - Min** and **Max:** the lowest and highest daily AC voltage and the time each was recorded.
 - Mode:** the inverter's present operating status (either buying or selling) and the number of kilowatts begin bought or sold. This is blank if an AC source is not present.
 - The **<Sell Status>** soft key (**F**) brings up possible reasons for not selling to the utility grid.
 - The **<Input Select>** soft key (**G**) returns to screens **A1** (FXR-class inverters) or **A2** (Radian-class inverters). It is not present in FX-class inverters.
- Screen Items (F):**
- Selling Disabled:** the **Offset Enable** (or **Grid-Tie Enable**) command is set to **N** (no). (See the *MATE3s Programming Guide*.)
 - Frequency** or **Voltage Too Low** or **Too High:** the AC voltage or frequency are outside the acceptable limits for selling.
 - Qualifying Grid:** the time to reconnection once all limits are met. (If the inverter is not a grid-interactive model, a random number may be displayed.)
 - Battery < Target:** the battery voltage is below the target for that stage (Float, Offset, etc). No excess energy is available to sell.
 - AC2 (gen) Selected:** The **Input Type** has been set to **Gen**. The inverter will not sell to a source that it identifies as a generator. (FX-class and FXR-class inverters only.)

Inverter Soft Key

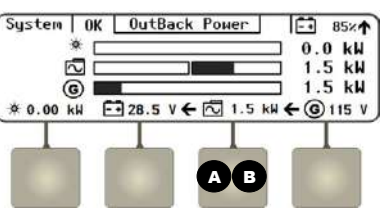

A and **B** are two different variations of the same screen showing different screen elements. Many other variations are possible. All screen elements are summarized below.

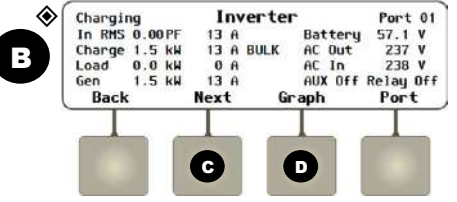
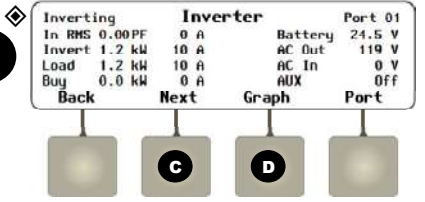

- Screen Items (some items apply only to A or B as indicated):**
- The upper left corner of the screen shows the present mode of operation (**Inverting**, **Charging**, or other modes).
 - In RMS:** the power factor and input current of the AC source.
 - Invert (A) or Charge (B):**
 - Invert** displays the kilowatts and AC current produced for loads, offsetting, or (when grid-interactive) sold back to the utility grid.
 - Charge** displays the kilowatts and AC current used to charge the battery bank. This line also shows the charge mode.
 - Load:** the kilowatts and AC current used by devices on the inverter's output. This may or may not be the same as **Invert**.
 - Buy (A):** the kilowatts and AC current brought into the inverter's input for both charging and loads. This is usually a total of the **Charge** and **Load** items and may equal **In RMS**.
 - Gen (B):** replaces **Buy** if the AC input mode is **Generator** or **Support**. The readings are the same. (FXR-and Radian-class only)
 - Battery:** the battery voltage. This reading is not compensated for temperature.
 - AC Out** and **AC In:** the AC voltage measured at the inverter's output and input. If an AC source is present, these readings are generally the same. However, they may not be identical due to meter tolerances. (In Radian-class inverters, each item is the sum of the L1 and L2 readings.)
 - AUX:** the status of the inverter's Auxiliary 12-volt output.
 - Relay (B):** the status of the inverter's Auxiliary relay contacts. (Radian-class only)

- The **<Next>** soft key (**C**) displays a series of screens with information on the inverter's charger and other battery-related functions, and on any inverter warnings or errors present. (See the next page.)
- The **<Graph>** soft key (**D**) displays a series of screens that plot various data over time. The graphs include inverter and charger wattage, power imported from an AC source, battery voltage, and others. The inverter wattage screen is shown here.

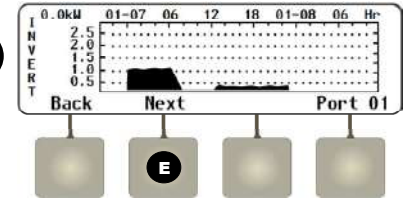

- The **<Next>** soft key (**E**) brings up a **Graph** screen with changes in charger wattage over time.
- Continuing to press **<Next>** brings up **Graph** screens for AC source (**Buy**) wattage, grid-interactive (**Sell**) wattage, and battery voltage.
- The battery voltage graph may also be used by other soft keys.

INVERTER MODES:

This section shows all possible modes. Some may not be available with all OutBack inverters. Incompatible or unavailable modes will not be displayed. See the inverter literature to determine which functions are available and their definitions.

- Inverting (A)**
- Searching**
- Support**
- Sell**
- Charging (B)**
- Charger Off**
- Offsetting**
- Silent**
- PassThru**
- Error**
- Off**

NOTES: **Charger Off** and **Silent** are not used in FXR models. If the inverter is a master or subphase master in Silent mode with AC input, the mode appears as **PassThru**. If an FXR inverter is used as a stacked slave, its only modes are **Slave On**, **Slave Off**, **Error**, **Inverting**, and **Off**.

- Slave On:** The slave inverter is assisting the master's activity (**Sell**, **Charging**, etc.).
- Slave Off:** The slave inverter is not assisting or performing any active function. **Slave Off** is also used if the master status is **PassThru**. Master and slave inverters may both be transferring (passing power through).
- Slave On** and **Slave Off** only appear when the AC input is in use. When no AC input is in use:
 - If the master is **Inverting**, the slave also displays **Inverting** while assisting with the inverting function.
 - If the slave is not actively assisting, it will display **Off** (not **Slave Off**).

Inverter Soft Key (continued)

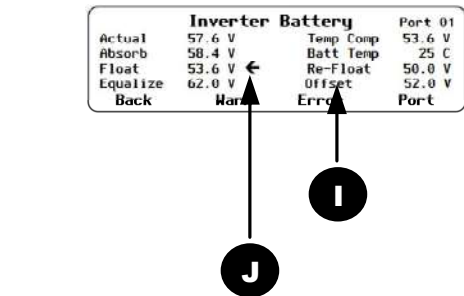
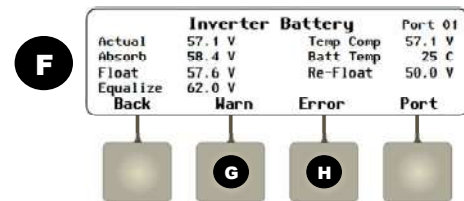
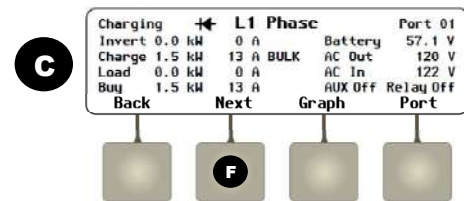

NOTES: There are several other variations on **C**, the <Inverter> soft key screen.

A diode symbol may be present to show “diode charging”, a low-power mode that allows fine control of charging, selling, and load support.

- In North American Radian-class inverters, *Inverter* is split into **L1 Phase** and **L2 Phase** screens (reached using the <Next> soft key **F**). The screens are almost identical, but the AC voltage readings are the individual L1 and L2 phases.
- From these screens, the <Next> soft key (**F**) brings up the *Inverter Battery* screen.

Screen Items (F):

- **Actual:** The battery voltage. This reading is not compensated for temperature. See below.
- **Absorb** and **Float:** The inverter’s primary charger settings for the three main charging stages.
- **Equalize:** The inverter’s Equalization voltage setting. It is used during the equalization cycle.
- **Temp Comp:** The battery voltage after compensation from the Remote Temperature Sensor (RTS). If no RTS is present, **Temp Comp** and **Actual** will read the same.
- **Batt Temp:** The battery temperature in degrees Celsius as measured by the RTS. If the RTS is measuring on an incorrect port, ### will be displayed. See the literature for the inverter, charge controller, or other product to determine the correct port.
- **Re-Float:** The inverter’s Re-Float setting. It is used to return the charger from Silent mode to the float stage.
- **Offset (I):** The inverter’s voltage used during Offset activities, including selling. This item is labeled **Sell RE** in older systems.

NOTE: If an arrow (**J**) appears next to **Absorb**, **Float**, or **Equalize**, it indicates the charger is in that stage. The arrow will not appear if the charger is in the bulk stage or Silent mode.

Warnings

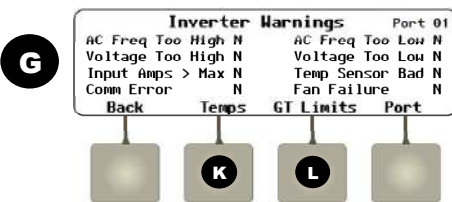

- The <Warn> soft key (**G**) displays a series of screens with a list of non-critical faults and other information. When an inverter suffers a warning, one or more items in **G** will change from **N** to **Y**.

A warning is also accompanied by an event message and the red **EVENTS** indicator (see pages 5 and 17). Some warnings can become errors if left unattended. Frequency and voltage warnings are meant to warn of a problematic AC source. See the inverter *Operator’s Manual* for more information on troubleshooting a specific warning.

Screen Items (G) which may appear:

- **AC Freq Too High** or **Too Low:** The AC source is above or below the acceptable frequency limit.
- **Voltage Too High** or **Too Low:** The AC source is above or below the upper acceptable voltage limit.
- **Input Amps > Max:** AC loads are drawing more current from the AC source than allowed by the input setting.
- **Temp Sensor Bad:** An internal inverter temperature sensor may be malfunctioning. This is also indicated by an unusual reading on the *Inverter Temps* screen (**K**). It may be called **Temperature Sensor Fault**.
- **Comm Fault:** See the entry under Errors. It only appears on this screen in older models. It may be called **Comm Error**.
- **Phase Loss:** A stacked inverter was ordered to transfer to an AC input source, but the source is the wrong phase or does not appear on the input.
- **Fan Failure:** The internal cooling fan is not operating properly. Lack of cooling may derate the inverter’s output wattage.

Errors

- The <Error> soft key (**H**) displays a screen with a list of critical faults. When an error occurs, the inverter will usually shut down. One or more screen items will change from **N** to **Y**. An error is also accompanied by an event message and the red **EVENTS** indicator (see pages 5 and 17). See the inverter *Operator’s Manual* to troubleshoot a specific error.

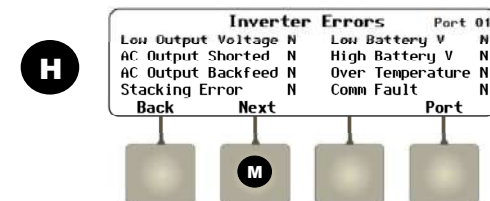

Screen Items (H) which may appear:

- **Low Output Voltage:** Inverter AC regulation cannot be maintained under high load.
- **AC Output Shorted:** Inverter maximum surge current was exceeded due to severe overload.
- **AC Output Backfeed:** Another AC power source (out of phase with the inverter) was connected to the AC output.
- **Stacking Error:** A programming problem among stacked units. (This often occurs if no master was assigned.)
- **Low Battery V:** DC voltage is below the Low Battery Cut-Out (LBCO) point. (See the *MATE3s Programming Guide*.)
- **High Battery V:** DC voltage is above the inverter’s maximum allowed level.
- **Over Temperature:** Maximum operating temperature was exceeded.
- **Comm Fault:** Inverter suffered an internal communication failure and may need service.
- **Phase Loss:** See the entry under Warnings. It only appears on this screen in older models.

NOTE: The <Next> soft key (**M**) appears in FXR and Radian (A and E model) inverters with additional items.

Screen Items (M) which may appear:

- **Loose DC Neg Terminals:** Loose DC connection on internal power module. May read **Loose DC Neg Terminals (L)** or **(R)**.
- **Battery Voltage Sense:** Internal sensing has detected voltages that are grossly outside the normal range.
- **AC Relay Fault:** AC transfer relay damaged.

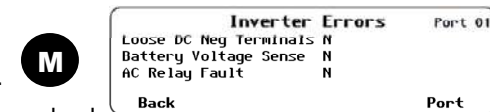

Temperatures

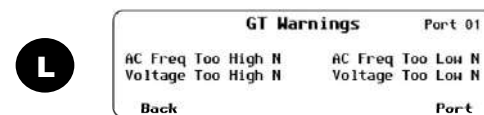
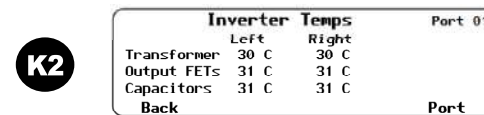
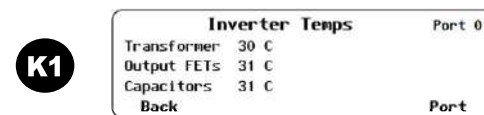

- The <Temps> soft key (**K**) displays the *Inverter Temps* screen. The internal temperature sensor readings are shown in degrees Celsius. The sensors are located on the main transformer, the heat sink for the Field Effect Transistors (FETs), and the filter capacitors. Normally all three read approximately the same. An unusual reading can indicate a defective sensor.

- **K1** shows these three readings for FX-class and FXR-class inverters. **K2** shows a total of six readings for Radian-class inverters. Radian inverters have twin (right and left) power modules. Each module has independent sensors and three separate readings.

- The <GT> soft key (**L**) displays the *GT Warnings* screen. It shows reasons why the inverter might stop selling power. If any reasons are valid, one or more items will change from **N** to **Y**. It is only available in Radian-class and FXR-class inverters in **Grid Tied** input mode. It is not visible in FX-class inverters. The screen may be called **IEEE Warnings**.

NOTE: The *GT Warnings* have the same names as the *Disconnect* messages shown on page 18, but they are not the same. *GT Warnings* have to do specifically with selling (or not selling) power, while the *Disconnect* messages are general reasons for disconnecting from any source.

Battery Soft Key

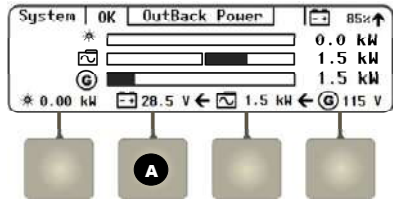

If the FLEXnet DC (FN-DC) battery monitor is installed, the **<Battery>** soft key (**A**) opens screen **A1**.

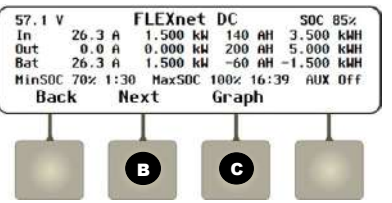

Screen Items (A1):

- The upper left corner of the screen shows the measured battery voltage. This reading is not compensated for temperature. The upper right corner shows the measured State of Charge (SOC).
- In:** The total current and kilowatts from all DC sources. It also shows the total amp-hours and kilowatt-hours delivered that day.
- Out:** The total current and kilowatts removed from the batteries for inverting, DC loads, or other uses. It also shows the total amp-hours and kilowatt-hours removed that day.

- Bat:** The net total current and kilowatts sent to or taken from the batteries. It also shows the net total amp-hours and kilowatt-hours collected or taken from the batteries that day.
- The last line shows both the highest and lowest recorded battery SOC for that day, and the time each was recorded.
- AUX:** The current status of the battery monitor's Auxiliary relay (also known as AUX mode or Relay mode). See the *MATE3s Programming Guide* and the FLEXnet DC manual.

The **<Next>** soft key (**B**) brings up a series of screens that show more detailed information on the battery. These screens also show data from individual shunts used with the FN-DC battery monitor.

Screen Items (B):

- Bat:** The battery voltage, net current flow (positive or negative), battery temperature, and daily net amp-hour accumulation.
- Min and Max:** The lowest and highest recorded battery voltage and SOC for that day and the time each was recorded.
- Days Since Parms Met:** The elapsed time since the "fully charged" parameters were met.

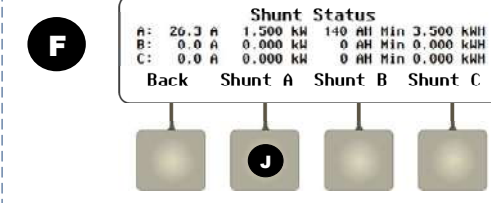
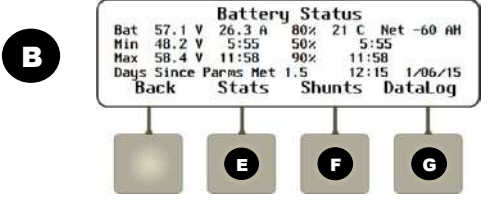

Screen Items (F):

- A, B, and C:** These display individual readings from up to three shunts (shunts A, B, and C). Each line shows the current and kilowatts measured at that time. It also shows the amp-hours and kilowatt-hours accumulated that day.
- The **<Shunt A>** soft key (**J**) opens the **Shunt A Historical Data** screen to display long-term statistics. Soft keys for **<Shunt B>** and **<Shunt C>** are also present. If a shunt is not enabled, its statistics will read 0.

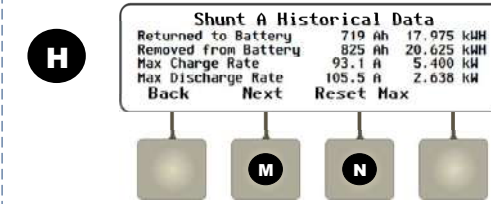

Screen Items (J):

- Returned to Battery and Removed from Battery:** These show the accumulated total amp-hours that have been delivered to the battery bank (charging) or removed from the battery bank (loads). Similarly, **Max Charge Rate** and **Max Discharge Rate** show the highest current entering or leaving the batteries.
- The **<Reset Max>** soft key (**N**) resets both current readings at the same time.
- The **<Next>** soft key (**M**) opens the **Historical Data** screen for the next shunt in alphabetical order (not shown).

If the FLEXnet DC (FN-DC) battery monitor is not present, the **<Battery>** soft key (**A**) opens screen **A2**.

Screen Items (A2):

- Bat:** The measured battery voltage. This reading is not compensated for temperature.
- Min and Max:** The lowest and highest recorded voltages that day. These lines also show the time the voltages were recorded.

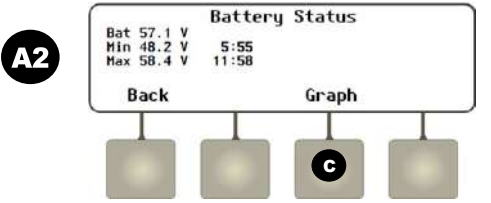

The **<Graph>** soft key (**C**) brings up a single graph showing changes in battery voltage over time. This graph may be used by other soft keys.

The **<Next>** soft key (**D**) brings up a **Graph** screen with changes in battery SOC over time (not shown). **D** and the following screens are only accessible from screen **A1** (if the FN-DC is installed).

Continuing to press **<Next>** brings up **Graph** screens for shunts A, B, and C (if present).

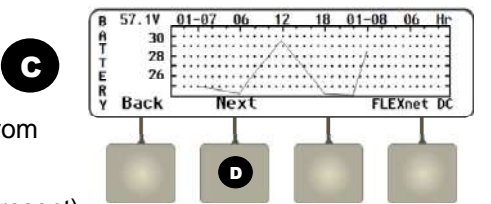

From the **Battery Status** screen, the **<Stats>** soft key (**E**) opens the **Battery Stats** screen. This shows long-term battery statistics.

Screen Items (E):

- Cycle Charge Factor:** A percentage comparison of amp-hours removed and those added by charging. It shows charging efficiency if compared to the programmed charge factor. Similarly, **Cycle kWh Charge Efficiency** compares removed kilowatt-hours to those returned to the battery from any activity (float charging etc.). It can be used to judge overall battery efficiency.
- Total Days at 100%:** The time since the batteries reached 100% SOC (according to the FLEXnet DC). If the batteries have not reached 100%, this will read 0. The time at 100% SOC is a running total which continues to accumulate until reset by the user.
 - The **<Reset Days>** soft key (**H**) resets this total.
- Lifetime kAH Removed** shows an accumulation of the total amp-hours that have ever been drained from the batteries.
 - The **<Reset kAH>** soft key (**I**) resets this total.

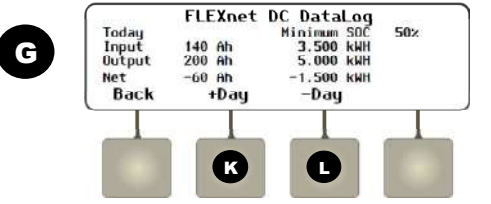

From the **Battery Status** screen, the **<DataLog>** soft key (**G**) opens the **FLEXnet DC DataLog** screen. It maintains a continuous daily log (up to 400 days) of amp-hour, watt-hour, and SOC statistics. One day can be displayed at a time.

Screen Items (G):

- Minimum SOC:** The lowest SOC for that day.
- Input and Output:** The number of amp-hours and kilowatt-hours brought into or removed from the batteries that day.
- Net:** The net gain or loss in amp-hours or kilowatt-hours that day. This is the difference between the **Input** and **Output** fields.
- The upper left corner shows the date of the selected **DataLog** screen. (The current **DataLog** screen reads **Today**.)
- The **<-Day>** soft key (**L**) brings up the previous day's log. Instead of **Today**, a date is shown. Similarly, the **<+Day>** soft key (**K**) advances the log by one day. If **Today** is displayed, it does nothing.

Charge Controller Soft Key

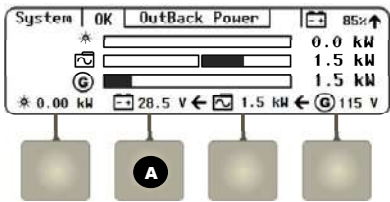

- The **<Charge Controller>** soft key (A) brings up FLEXmax charge controller status data. If no charge controller is present, the PV icon is blank and this soft key is inoperative. The reading above this key shows the PV kilowatts used to charge the battery.

Screen Items (A):

- The upper left corner of the screen shows the present mode of operation (**Bulk**, **Absorb**, **Float**, **EQ**, or **Silent**).
- In**: The present PV array operating voltage and the current harvested from the array.
- VOC**: The available PV open-circuit voltage.
- Out**: The present battery voltage and the controller(s) battery charging current. This line also displays the daily accumulated kilowatt-hours and amp-hours.
- Operating**: The total hours the charger has operated that day in any stage.
- Float** and **Absorb**: The run time of the timers when in either stage.
- Maximum**: The maximum daily PV current and wattage and the recorded times.
- The lower right corner shows the current status of the charge controller's Auxiliary (AUX) output. (See the *MATE3s Programming Guide* and the charge controller manual.)

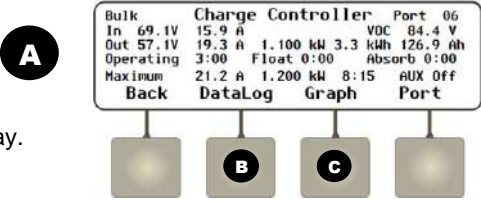

- The **<DataLog>** soft key (B) brings up the **Charge Controller Datalog** screen. It maintains a continuous daily log (up to 128 days) of amp-hour and watt-hour statistics, as well as maximum current, wattage, and maximum and minimum voltage figures. One day can be displayed at a time.

Screen Items (B):

- Max Output**: The maximum daily current and wattage.
- Absorb** and **Float**: The amount either of these timers ran that day.
- High VOC**: The highest daily open-circuit voltage (VOC).
- Min Batt** and **Max Batt**: The lowest and highest daily battery voltage.
- The upper left corner shows the date of the selected **DataLog**. (The present **DataLog** screen reads **Today**.)
- The **<-Day>** soft key (E) brings up the previous day's log. Instead of **Today**, a date is shown.
- Similarly, the **<+Day>** soft key (D) advances the log by one day. (If **Today** is displayed, it does nothing.) This line also displays the daily accumulated kilowatt-hours and amp-hours.

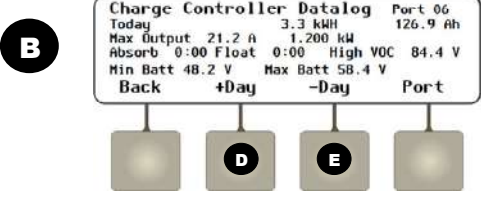

- The **<Graph>** soft key (C) brings up screens that plot different kinds of charge controller information. Shown here is the first **Graph** screen. This screen shows changes in PV wattage over time.
 - The **<Next>** soft key (F) brings up a **Graph** screen (not shown) with changes in battery voltage over time. This graph may be used by other soft keys as well.
 - Continuing to press **<Next>** brings up a **Graph** screen with changes in PV voltage over time.

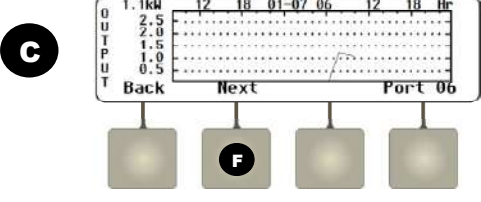

Hot Keys

Six "hot" keys display the most common operational screens. Some screens have selectable modes (On, Off, etc.) while some show function status. Some screens have their own soft keys and menus. The measurements and status messages are collective readings for the system, not for an individual inverter, unless specified otherwise. Similarly, commands are usually global unless specified otherwise.

INVERTER

The **INVERTER** hot key (A) brings up **Inverter Status**, with mode commands and readings. In a stacked system, the mode commands are global. Kilowatt readings are a total of all inverter measurements. Kilowatt-hour readings are daily accumulations which are reset to zero at midnight. All voltage readings are taken from the master inverter.

In Radian-class or FX-class models, **INVERTER** brings up screen **A1**. In FXR-class models, **INVERTER** brings up screen **A2**.

- The **<On>** and **<Off>** soft keys (B or C) send **On** or **Off** commands to all inverters. The **<Search>** soft key (D) toggles in or out of Search mode.
- Mode**: This displays the soft key selection (**On**, **Off**, or **Search**) using soft keys **B**, **C**, or **D**.

Screen Items (A1):

- Battery**: The measured battery voltage, not compensated for temperature.
- Input**: The AC source voltage and the power in kilowatts from the source.
- Output**: The voltage measured at the inverter's output and the kilowatts produced. The produced power may equal the load wattage, but can also include power sold to the grid.
- Load** displays the kilowatts delivered to the inverter's output.

Screen Items (A2):

- AC In**: The input source voltage. This line also displays kilowatt and kilowatt-hour readings. A kilowatt reading under **To** means the inverter is exporting (selling) power to the AC input. This only occurs in grid-interactive applications (with the inverter's **Grid Tied** mode). A **To** kilowatt-hour reading is the daily energy sold by the system. A kilowatt reading under **From** means the inverter system is importing (buying) AC power from the source, either for charging or for loads. A **From** kilowatt-hour reading is the daily energy imported by the system.
- AC Out**: The voltage measured at the inverter's output. This line also displays kilowatt and kilowatt-hour readings. A kilowatt reading under **To** means power is delivered to the AC output for loads. This may be inverted power (as shown under **Batt**) if no AC source is present. If a source is present, it may mean either offset power (see **Batt**) or power imported from the AC source (see **AC In**). A **To** kilowatt-hour reading is the daily energy delivered by the system. A kilowatt or kilowatt-hour reading under **From** is power received from the AC loads. This only occurs in AC Coupling applications.
- Batt**: The measured battery voltage, not compensated for temperature. This line also displays kilowatt and kilowatt-hour readings. A kilowatt reading under **To** means the inverter is delivering power to charge the batteries. This is imported power from the AC source (see **AC In**). A **To** kilowatt-hour reading is the daily charging energy delivered by the system. A kilowatt reading under **From** means the inverter is converting battery power to AC. If no AC source is present, this is inverted power used to operate loads (see **AC Out**). If an AC source is present, this may be either offset power (see **AC Out**), or power sold to the AC source (see **AC In**). A **From** kilowatt-hour reading is the daily energy delivered from the batteries.

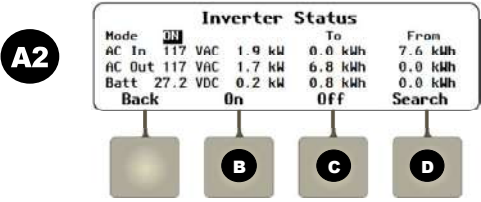
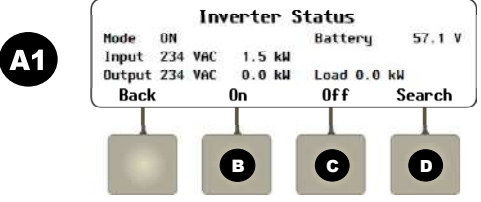
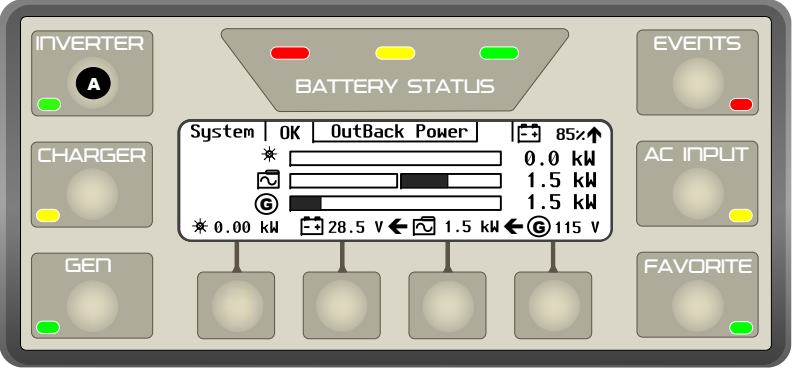

CHARGER

The **CHARGER** hot key (A) brings up **Charger Status**, with readings and mode commands for charger(s) and equalization.

NOTE: This data is for inverter/chargers only. In a stacked system, it shows the master inverter status. If another inverter or a charge controller has a different status, it will not be displayed.

Screen Items (A):

- **Battery:** The measured battery voltage, not compensated for temperature.
- **Charger Control:** The charger mode setting.
- **Absorb:** The target voltage for the Bulk and Absorption stages.
- **Float:** The target voltage for the Float stage.
- The **<Bulk Charge>** soft key (B) brings up the **Bulk Charge** screen. A charge cycle can be started or stopped
- The **<EQ Charge>** soft key (C) brings up the **EQ Charge** screen for equalization.
- The **<Charger Mode>** soft key (D) brings up the **Charger Mode** screen.

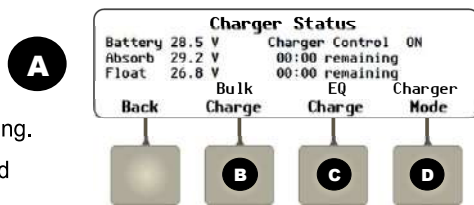

Screen Items (C):

- **Battery:** The actual battery voltage, not compensated for temperature.
- **Equalize:** One reading shows the status of this mode. The other is the target voltage for equalization. The timer runs once this voltage is reached.
- **Last EQ charge:** The date and time for the latest cycle.
- **Check Battery Water Level Before Starting** is not a changeable menu item. The text is offered as advice for equalization.
- The **<Start EQ>** and **<Stop EQ>** soft keys (G and H) control the equalization cycle. G leads to additional text. I leads to a confirmation screen (not shown) to avoid accidental equalization. Pressing the **<Yes>** key on that screen starts the process and returns the screen to C. Equalization proceeds automatically and stops at the end of the process. The **<Stop EQ>** soft key (H) can stop equalization manually if necessary.

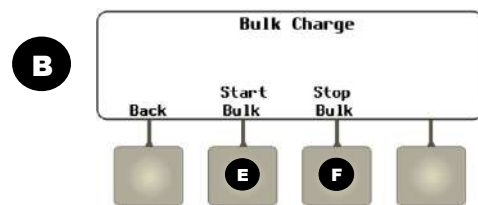

Screen Items (B):

- The **<Start Bulk>** soft key (E) starts a new charging cycle. **Bulk Charge Started** is displayed.
- The **<Stop Bulk>** soft key (F) halts a cycle. **Bulk Charge Stopped** is displayed.

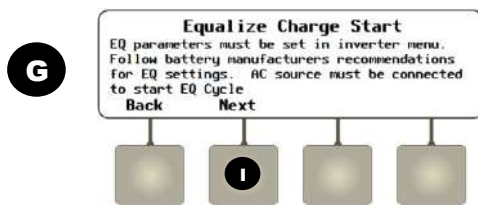
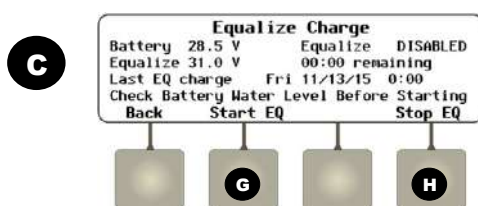

Screen Items (D):

- The **<On>** soft key (J) activates the charger to conduct a charge according to its settings.
 - FXR- and Radian-class chargers use ABC (Advanced Battery Charging) settings to select the cycle.
 - If an individual charger was disabled with **Charger Control** in the FXR inverter menu, J cannot activate it. See the *MATE3s Programming Guide* and the inverter manual.
 - FX-class chargers use a standard three-stage cycle (bulk, absorption, and float). Afterward the charger remains in the float stage.
 - In grid-interactive FX models, **<On>** is automatically selected when **Input Select** is set to **Gen** (see page 8). **<On>** cannot be selected if **Input Select** is set to **Grid**. **<Off>** can still be selected.
- The **<Off>** soft key (K) disables the charger regardless of settings or operation. It will not function until J or L is pressed.
 - The charger will operate even when set to **<Off>** if AGS is enabled. See the *MATE3s Programming Guide*.
- The **<Auto>** soft key (L) activates a three-stage cycle. Upon completion, the charger cycles between float stage and Silent mode. This key is only present in FX-class chargers. It is not present in FXR-class or Radian-class models.
 - In grid-interactive FX chargers, **<Auto>** is automatically selected when the **Input Select** menu is set to **Grid** (see page 8). **<Auto>** cannot be selected if the menu is set to **Gen**. **<Off>** can still be selected.
 - In FXR-class and Radian-class chargers, this key is not present. The ABC settings choose the Silent or float stages.

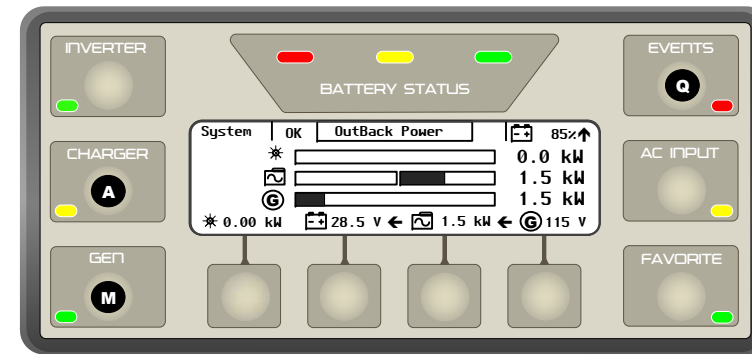
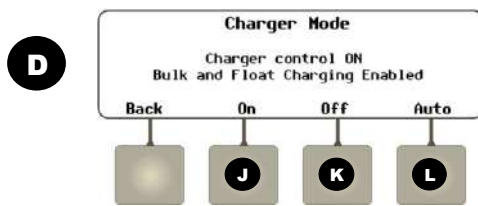

GEN

The **GEN(erator)** hot key (M) brings up **Generator Status**, with readings and start/stop commands for the Advanced Generator Start (AGS) mode.

M1 is the screen as it appears with no generator activity.

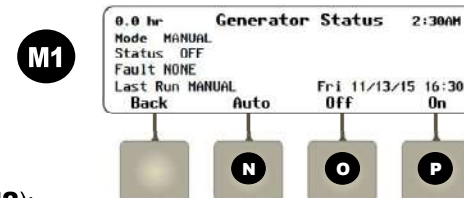

Screen Items (M1 and M2):

- The **<On>** and **<Off>** soft keys (O and P) manually start and stop the generator. The **<Auto>** soft key (N) allows the generator to start with automatic parameters set by the user in the AGS menu.
- The figure to the left of the **Generator Status** title displays accumulated generator run time. This counter can be reset.
- **Mode:** The selection made above (**Auto**, **Off**, **On**) using soft keys N, O, or P. It reads **AGS DISABLED** if AGS is turned off.
- **Status:** The current status of AGS. If not operating the generator, it reads **OFF**. If active, it may read **STARTING** or **RUN**.
- **Fault:** Displays the message **AGS Fault** if the generator voltage is lost. Otherwise, it displays **NONE**.
- **Last Run:** The reason of the last generator start. The date and time of the start appears to the right of the reason.

See the *MATE3s Programming Guide* to program, change, or reset AGS items. The document also has a list of generator start and stop reasons.

When **<On>** (P) is pressed, generator data appears on the right side of the screen (M2).

M2 is the screen as it appears with generator activity.

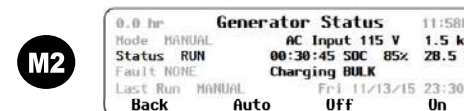

- The first line displays the generator's AC voltage and the generator kilowatts used.
- The second line displays the updated status **RUN**, the time since the start command was sent, the battery state of charge (**SOC**), and the battery voltage. (If the FN-DC battery monitor is not present, the **SOC** field will be blank.)
- The third line displays the stage of the battery charging cycle.

NOTE: The generator can only be started if the AGS mode is enabled in **AGS Setup** (see the *MATE3s Programming Guide*). If it is not enabled, this information will not appear.

EVENTS

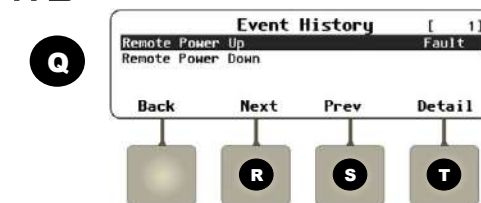

The **EVENTS** hot key (Q) brings up **Event History**. (See page 5 for the definition of an event.) This screen can scroll through each event and display the details to determine if corrective action is required. An event may need acknowledgement before the **EVENTS** LED indicator will turn off.

Event logs can be saved to an SD card. See the *MATE3s Programming Guide* for instructions on saving event logs. The document also has more information on troubleshooting event messages.

Screen Items (Q):

- The left side of the screen lists the nature of the event.
- The word **Fault** will appear on the right side of the screen if the event requires acknowledgement.
- The **<Next>** and **<Prev>** soft keys (R and S) highlight the next and previous events in the list. The control wheel will also scroll up and down this list.
- The **<Detail>** soft key (T) brings up the **Event History Detail** screen.
- The **Event History Detail** screen (T) displays the details of the selected event, and prompts for acknowledgement, if necessary. Using the control wheel will display the detail for the previous, or the next, event as listed in the **Event History** screen.



Screen Items (T):

- If the **<Ack>** and **<Ack All>** soft keys (U and V) appear, either must be pressed to acknowledge the event. Once acknowledged, the **EVENTS** indicator will turn off. An acknowledgement (**ACKED**) will replace the word **Fault** in the **Event History** screen.
- The **<Ack>** soft key (U) acknowledges a single open event.
- The **<Ack All>** soft key (V) acknowledges all open events.

AC INPUT

The **AC INPUT** hot key (A) brings up **AC Input Status**, with information on the AC source. It also has commands that can connect or disconnect from the source.

Screen Items (A):

- **AC Input Select** (Radian-class only): This displays which of two inputs was set as first priority for the inverter. (See the *MATE3s Programming Guide* to make this selection.) This item is not present in FX-class or FXR-class inverters.
- The top line also displays the present AC voltage and frequency from the input source.
- **Input Mode**: Allows soft key options to change the mode. This may be overridden by other commands. For example, a system set to **Drop** will automatically switch to **Use** if AGS starts the generator.
- Next to **AC Input Select** is the last reason the status was changed. In **A**, the change is due to an **HBX-SOC** event. Other possible reasons are **Manual**, **AGS**, **Grid-Time**, **Load Grid**, or **HBX-Voltage**. See the *MATE3s Programming Guide* for more information.
- **AC Input Status**: This displays the current interaction with the AC input. This screen will usually change to match **AC Input Mode** once a soft key command is given. In Radian-class inverters, the displayed AC voltage is the sum of the L1 and L2 phases.
- The **<Drop>** and **<Use>** soft keys (**B** and **C**) manually disconnect or connect to the AC source.
- The **<Discon>** soft key (**D**) displays a screen with the reason for the last AC disconnect.

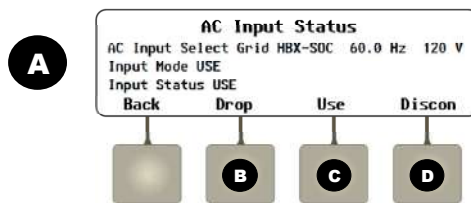

Screen Items (D):

This screen shows the reason for the inverter's last automatic disconnection from the AC source. The possible reasons include **Input Frequency Too High**, **Input Frequency Too Low**, **Input Voltage > Maximum**, or **Input Voltage < Minimum**. Radian-class and FXR-class inverters have **Backfeed**, **Phase Lock**, or **Island Detect**. Most items show **N** (no). If an item shows **Y** (yes), the inverter disconnected for that reason.

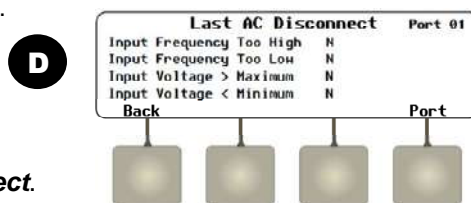

FAVORITE

The **FAVORITE** hot key (E) allows the user to program and select up to four frequently used (or "favorite") screens for rapid access. It includes a green LED indicator.

To program the FAVORITE hot key:

1. Navigate to the desired screen.
2. Press and hold the **FAVORITE** hot key until the green indicator flashes.
3. Press one of the four programmable soft keys to select it for recalling that particular screen. The green **FAVORITE** LED indicator will stop flashing.
4. Repeat Steps 1-3 to program three more favorite screens (if desired).

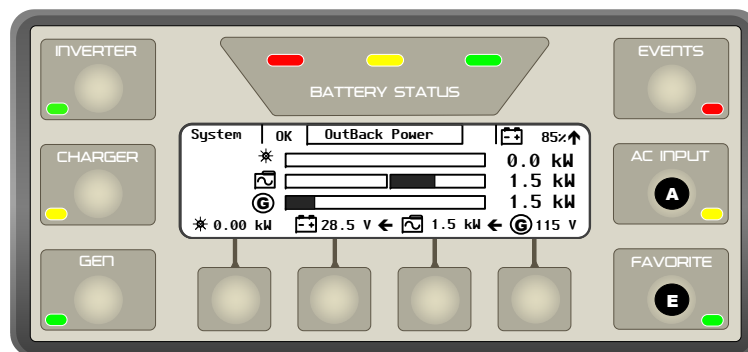

To use the FAVORITE hot key to recall the desired screen(s):

1. Press and release the **FAVORITE** hot key. The green **FAVORITE** indicator will illuminate and stay on.
2. Press the soft key for the desired screen to be recalled.

If no selection is made after pressing the **FAVORITE** hot key, the function will deactivate and the green indicator will turn off.



IMPORTANT

Only one favorite screen can be programmed per soft key. Attempting to program more than one screen to the same soft key will overwrite the first screen.

Password-protected screens cannot be saved as favorites. This means that the screens described in the *MATE3s Programming Guide* cannot be saved this way. (These include any screens accessed with the **LOCK** key.)

Firmware Updates

The MATE3s, the inverter, and other OutBack products can be updated to the latest revision by installing the latest firmware. Firmware can be ordered on a preloaded SD card, or downloaded from the website www.outbackpower.com or www.alpha-outback-energy.com. The firmware is available for download on the MATE3s product page or the Firmware page shown below. The page in this image is accessed using the Support tab (A).

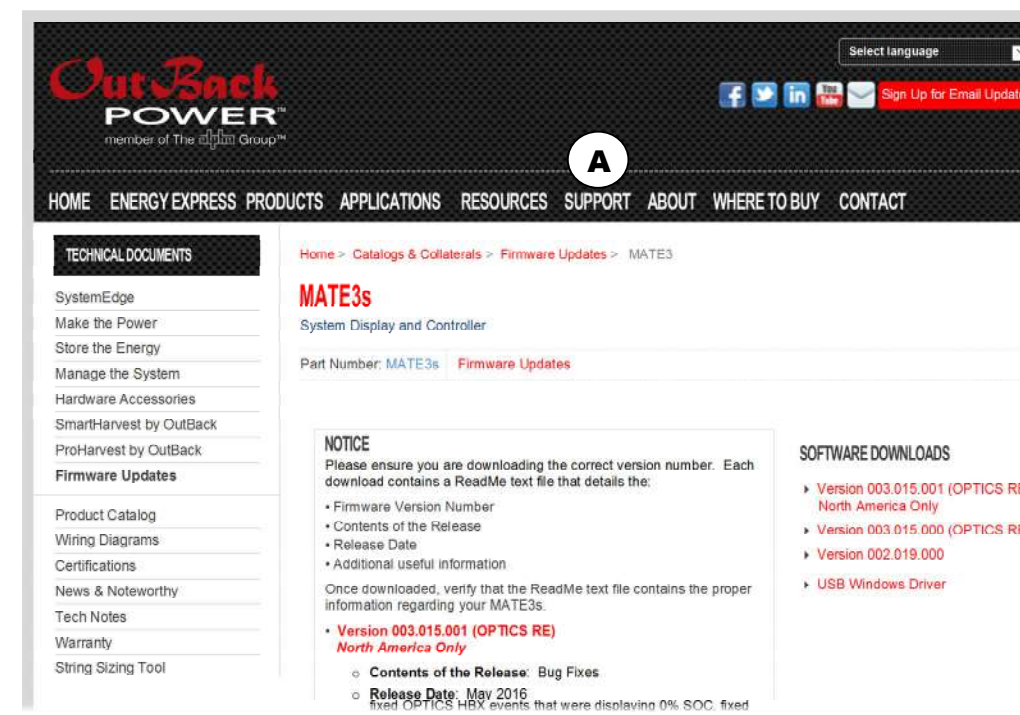

To download firmware:

1. Remove the SD card from the MATE3s. (See B.)
2. Reformat and erase all existing files on the SD card. Make certain the card uses FAT16 or FAT32 format.

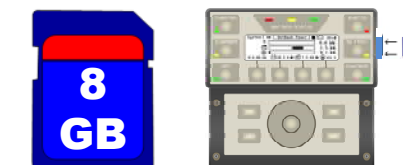

CAUTION: EQUIPMENT DAMAGE

Make certain all card contents are removed. If previous firmware or files remain on the card during installation, the MATE3s could be permanently corrupted.

3. From the OutBack page, download the latest firmware revision (C).



IMPORTANT

Make certain to extract (unzip) the files to the SD card. Do not save the file directly in its original compressed form. If the files are downloaded in compressed form, they will be unusable.





Worldwide Corporate Offices			
<p>Headquarter Germany Hansastraße 8 D-91126 Schwabach Tel: +49 9122 79889 0 Fax: +49 9122 79889 21 Mail: info@alpha-outback-energy.com</p>	<p>Eastern Europe ee@alpha-outback-energy.com</p> <p>Middle East me@alpha-outback-energy.com</p>	<p>France and Benelux fbnl@alpha-outback-energy.com</p> <p>Spain spain@alpha-outback-energy.com</p>	<p>Russia russia@alpha-outback-energy.com</p> <p>Africa africa@alpha-outback-energy.com</p>

Alpha and Outback Energy GmbH reserves the right to make changes to the products and information contained in this document without notice. Copyright © 2020 Alpha and Outback Energy GmbH. All Rights reserved.

For more information please visit www.alpha-outback-energy.com